

Data Sheet

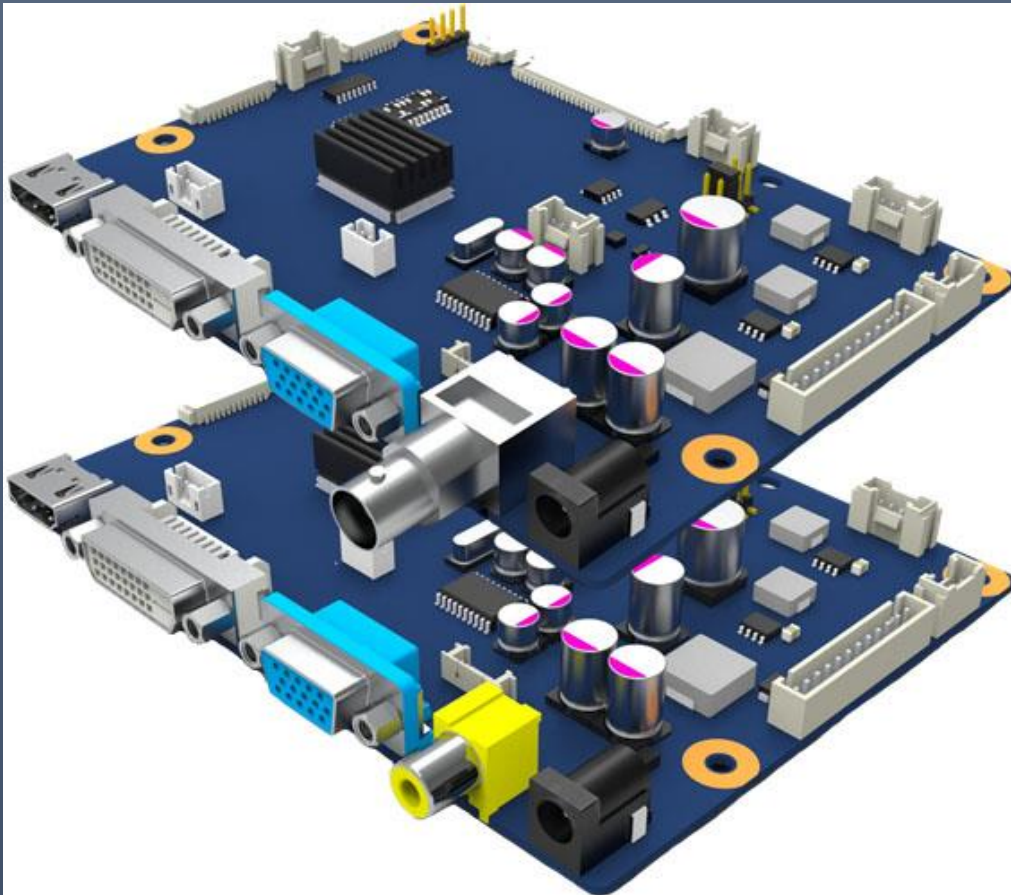

Venus4 Board

Part No.: *VNS4-LVDS-xxx....xxx*
VNS4-BNC-xxx....xxx
VNS4-TTL-xxx....xxx
(xxx...xxx : target LCD part No)

CONTENTS

Revision History	5
1. Spec Summary.....	6
2. General Description.....	6
3. Block Diagram.....	7
4. Dimension and Pictures - Main Board	8
4.1 Main Board (140 x 100 mm).....	8
4.2 Main Board Picture.....	9
5. Dimension and Pictures - OSD Board	12
5.1 5Key OSD Board Type 1 : (108.9 x 19.5 mm).....	12
5.2 5Key OSD Board Type 2 : (127.0 x 20.0 mm).....	12
6. Connectors and Pin information	14
6.1 Connectors Summary	14
6.2 Pin Information Detail.....	15
6.2.1 8-bit LVDS output : LVDS 30Pin (12507WR-30P) / CN14	15
6.2.2 Extra LVDS output for 10-bit panel : LVDS 4Pin (12507WR-04P) / CN15	15
6.2.3 DVI Input (DVI D-Type).....	15
6.2.4 HDMI Input.....	15
6.2.5 VGA Input (D-SUB 15Pin).....	15
6.2.6 RS232C Control : CN12 (SMW200-04)	15
6.2.7 C-VBS Input : (RCA Jack) C-VBS Input : (BNC Jack).....	15
6.2.8 Inverter Interface : CN3 (SMAW200-06).....	16
6.2.9 OSD Interface : CN9 (12505WR-12).....	16
6.2.10 12V DC In : (DC-005).....	16
6.2.11 SMPS Interface : CN2 (SMW250-12)	16
6.2.12 Touch Controller Power : CN4 (SMAW200-04)	16
6.2.13 Audio output & Control : CN16 (SMAW200-05)	16
6.2.14 internal USB : CN11 (12505WR-08)	16

6.2.15	I2C Extension(option) : JP3(1*3 2.54mm HEADER).....	16
6.2.16	Speaker for HDMI input: CN10 (SMAW200-04), 2W x 2W	16
6.2.17	LVDS Output(Optional) : CN17(FX8C-60P-SV2)	16
6.2.18	Service Port : CN20 (12505WS-06).....	17
6.2.19	Analog Audio-In : CN208 (PHR-03).....	17
6.2.20	UART Port : CN206 (PHR-04).....	17
7.	Setup for Operation.....	18
7.1	Functions on OSD Menu	18
7.2	Hot Key.....	18
7.3	Menu Selection on the OSD Menu.....	19
7.4.	OSD Menu Tree	19
7.4.1	Picture Menu	20
7.4.2	Option Menu	21
7.4.3	Function Menu	22
7.4.4	Setup Menu	23
8.	Applicable Graphic Mode.....	24
9.	Appendix - A (Option : 24V DC Power Board).....	25
9.1	Block Diagram.....	25
9.2	Dimension and Picture (90x45 mm).....	26
9.3	Pin Information.....	27
9.3.1	J1 & J4 / Inverter Control output Connector SMW200-H10G / Yeon-Ho.....	27
9.3.2	J3 / Inverter Control input Connector SMW200-H05G / Yeon-Ho.....	27
9.3.3	J2 / 12V DC Output Connector SMW200-H04G / Yeon-Ho.....	27
9.3.4	J5 / 24V DC Jack Connector DIN-422(BSUN) / Yeon-Ho.....	27
9.3.5	J6 / 24V DC Power Input Connector SMW200-H10G / Yeon-Ho.....	27
9.3.6	J7 / 24V DC Power Input Jack (round type) / Yeon-Ho.....	27
10.	Appendix - B (Option : LVDS Receiver board).....	28
10.1	Top View	
10.2	Bottom View.....	28

10.3	Pin Information.....	29
10.3.1	CN1 TTLout FPC 33P(0.5mm Pitch).....	29
10.3.2	CN7 TTLout FPC 30P(1mm Pitch).....	29
10.3.3	CN5 LVDS IN.....	29
10.3.4	CN6 PWR IN.....	29
10.3.5	CN2 PWR OUT.....	29
11.	Appendix - C (Option : Service Menu) – only for system integrator.....	30
12.	Appendix - C (Option : RS232C Protocols).....	32
12.1	RS-232 Serial control.....	32
12.2	Physical connection.....	32
12.3	RS-232 Serial Protocols.....	32
13.	Appendix – E (Dip Switches' Setting & supportable LCD List).....	36
13.1	Reference Data.....	36
13.1.1	Limiting Value.....	36
13.1.2	Etc. Data.....	36
13.2	Option Jumper Setting.....	36
13.2.1	LCD Vcc Selection Jumper (JP1).....	36
13.2.2	Inverter Control Selection ; SW1.....	36
13.2.3	LVDS Type selection; SW1.....	37
14.	Appendix – F (Firmware Upgrade).....	38
14.1	The download through USB port (CN11 connector at the left top on the PCB).....	38
14.2	The download through VGA port on Venus4 board.....	38
15.	Appendix – G (Electrical Specification).....	39
15.1	Electrical Specification.....	39
15.2	Power Block Diagram.....	40

1. Spec Summary

- State of the art high performance picture quality complying with Broadcasting Monitor and Medical Monitor
- Analog RGB / DVI / HDMI 1.4 / CVBS
- Full CRT multi-sync monitor compatibility
- Multi-sync capability up to WUXGA resolution @ 60Hz, compatible standard
- DOS, VGA, SVGA, XGA and SXGA / WUXGA VESA timing
- Expand DOS, VGA and SVGA to full screen display
- **10-bit data processing and 10-bit LVDS output, TTL output and 10V Vcc supportable circuit by optional daughter board**
- Single control operated On-Screen-Display(hereafter "OSD") user interface
- Full control of all relevant display and interface parameters via OSD
- Multi language support
- VESA DDC 1/2B compliant
- Compatible with VESA DPMS power saving modes
- Small form factor: 140 x 100 x 20 mm
- Operating Temperature : -30°C ~ +80°C
- Multi-standard color system at CVBS (PAL / NTSC)
- Image **Flip / Mirror** supportable by AD board
- Serial Control (RS232C) ready / Customized protocol setting (optional contract basis)
- Audio support (2W x 2W speaker out)
- Power : 12V DC Power adaptor, SMPS (Optional select)
- Optional Power : 24V DC by an additional Daughter Board (Appendix-A)
- User can choose the type of Composite Video jack : RCA type or BNC type

2. General Description

Venus4 provides the most versatile features specialized for industrial usage. Keys can be configured as various features for specific application and requirement from single feature to hotkeys for their maximum convenience.

Also, through the hidden service menu, system integrator can tweak various settings related to backlight control such as "Direction inversion", "Minimum Brightness Limit", "Maximum Brightness Limit" and "PWM Frequency from 120Hz to 500KHz".

In addition to the above, the backlight adjustment can be configured as "Linear" and "Curved" for wide dimming ratio application such as marine and airport application that need to see in the dark.

3. Block Diagram

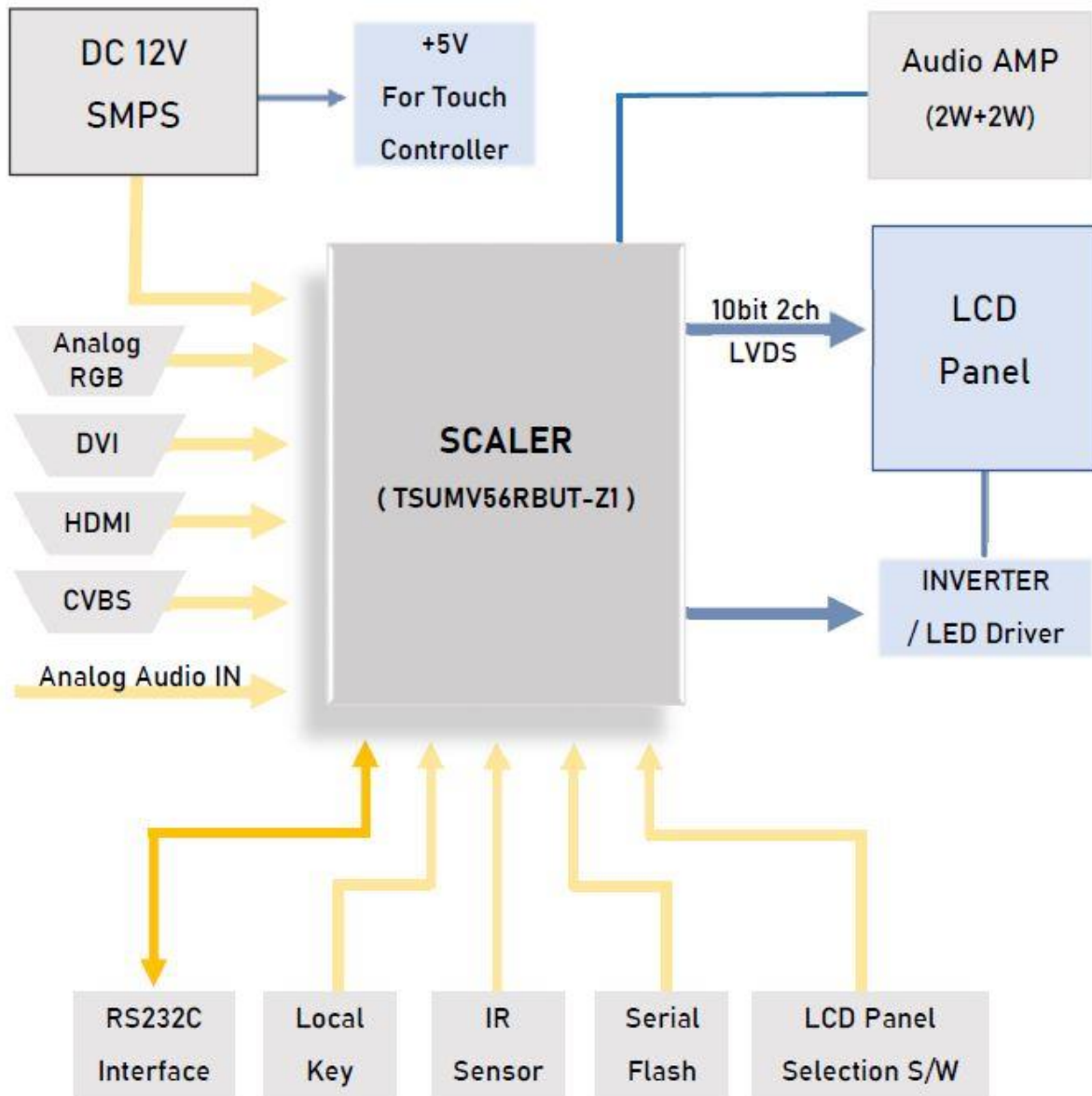

4. Dimension and Pictures - Main Board

4.1 Main Board (140 x 100 mm)

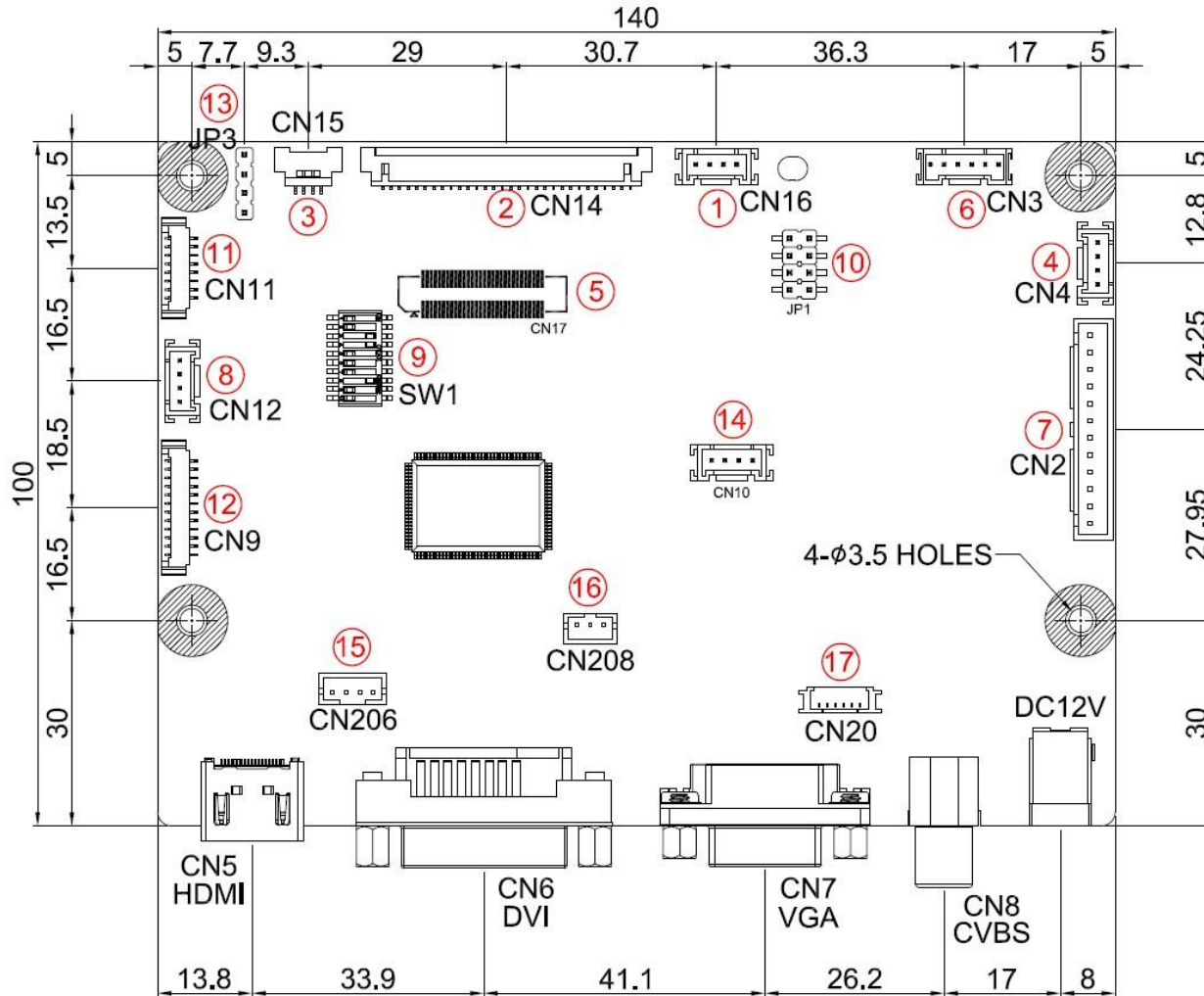

no	CON	Service
1	CN16	Audio Volume Controller (Analog Audio connection port)
2	CN14	8-bit LVDS to LCD Panel
3	CN15	Extra LVDS for 10-bit Panel
4	CN4	Touch Power Controller
5	CN17	LVDS Output(Optional)
6	CN3	Inverter
7	CN2	12V DC from SMPS or System Power
8	CN12	RS232 Serial Connector
9	SW1	LCD Panel Selection (Switch 1~7) LVDS Format Selector (Switch 8, JEIDA or VESA) LVDS Selector (Switch 9, 8 Bit or 10 Bit) Dimming type Selection (Switch 10, PWM or Analog)
10	JP1	LCD Panel Vcc (3.3 / 5 / 10 / 12 volt) Selection Jumper
11	CN11	USB for Firmware update
12	CN9	OSD
13	JP3	I2C Control / CDS
14	CN10	Speaker (Audio out)
15	CN206	UART Port
16	CN208	Analog Audio-in Port
17	CN20	Service Port

4.2 Main Board Picture

Plane View for BNC Type Composite Video version

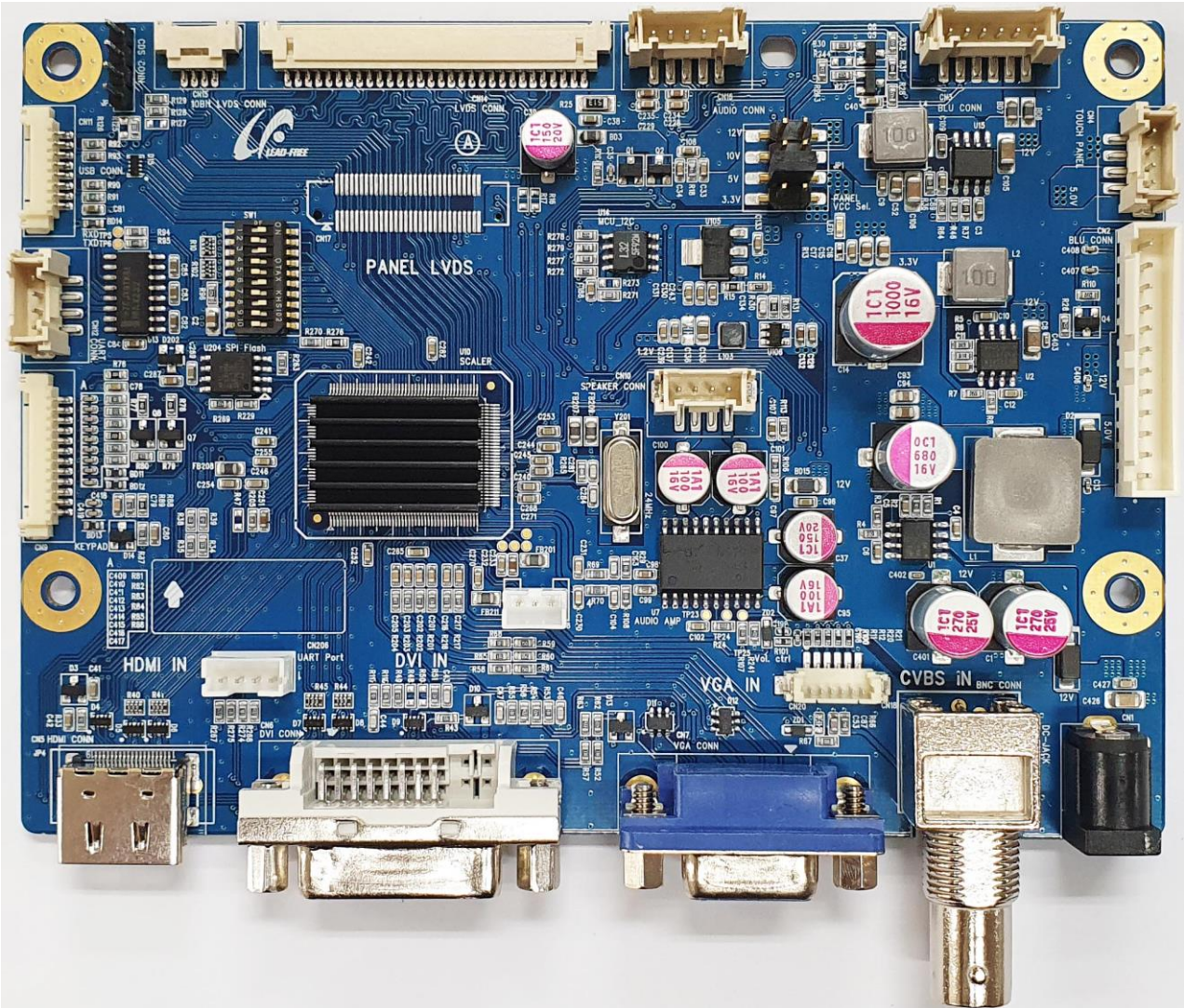

Front View



The part numbers for PO are :

- VNS4-BNC-xxx....xxx : the composite video jack with BNC Connector
- VNS4-BNCSOG-xxx....xxx : the composite video jack with BNC Connector and the SOG (Sync On Green) function applied on the firmware as an option

The "xxx...xxx" means the target LCD Part Number.

Plane View for RCA Jack Type Composite Video version

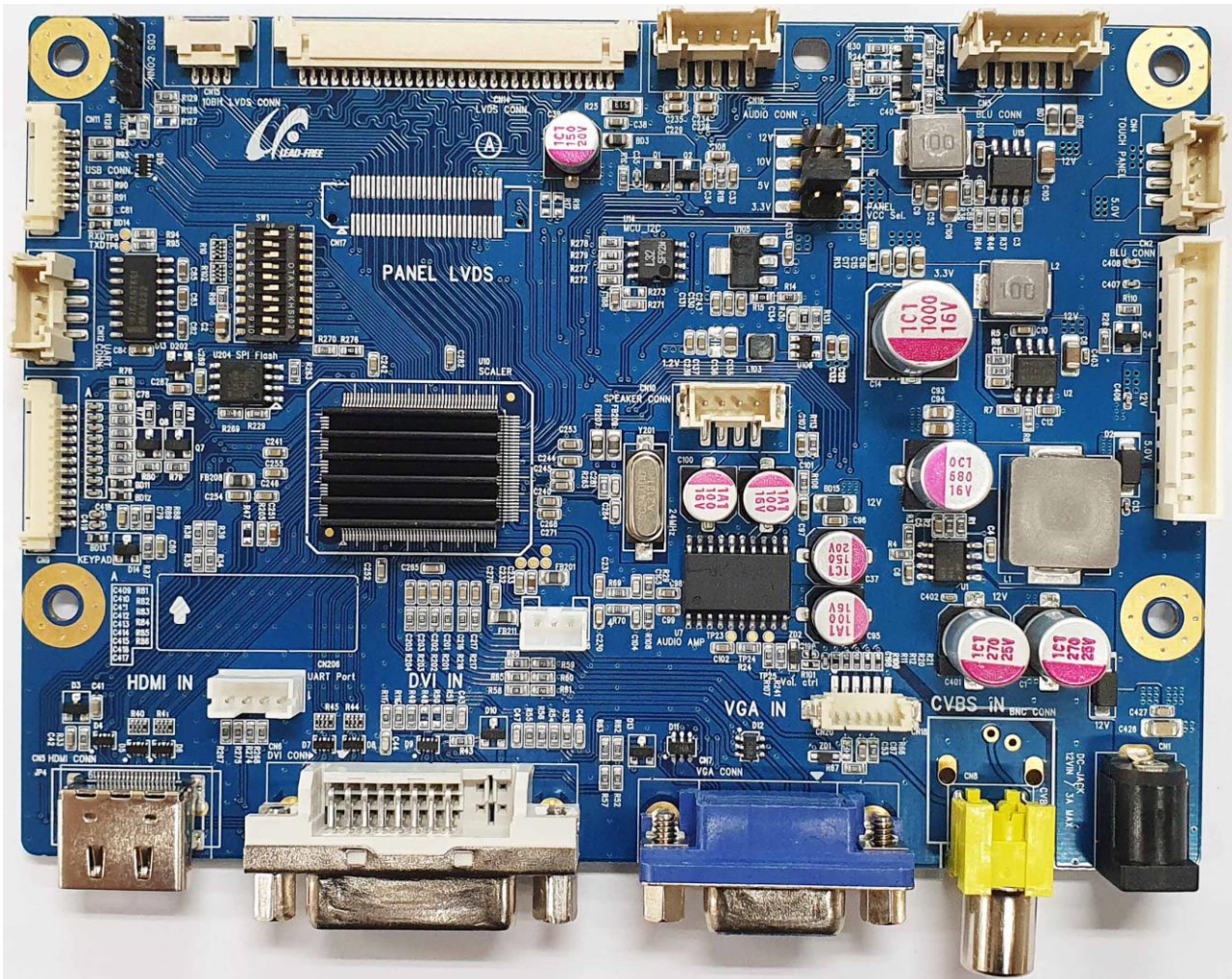

Front View

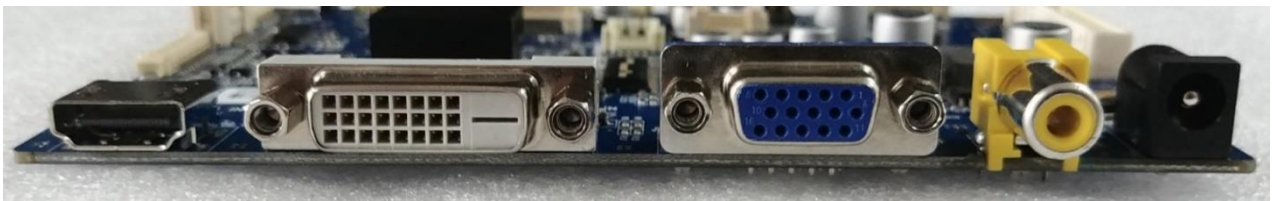

The part numbers for PO are :

- VNS4-LVDS-xxx....xxx : the composite video jack with RCA Connector
 - VNS4-TTL-xxx....xxx : the composite video jack with RCA Connector and the TTL interface by an optional Daughter Board addition (refer to the page 35 ~ 36 / Appendix C)
- The "xxx...xxx" means the target LCD Part Number.

Assembled shape of VNS4 and LVDS Receiver Board (refer to the Appendix B)

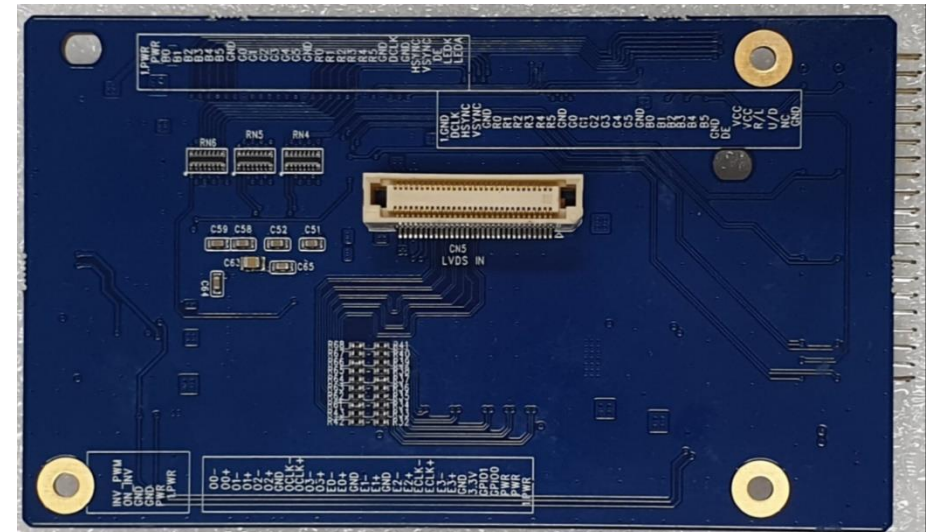
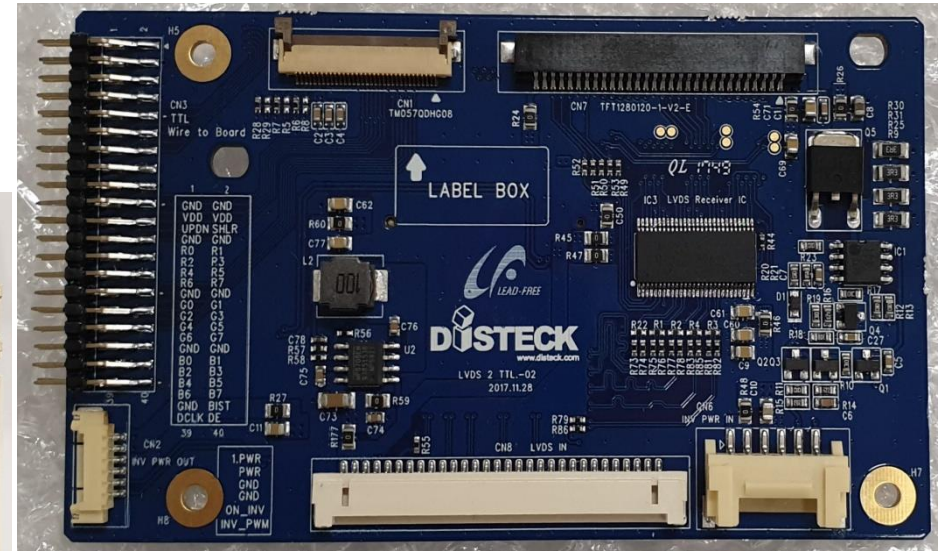
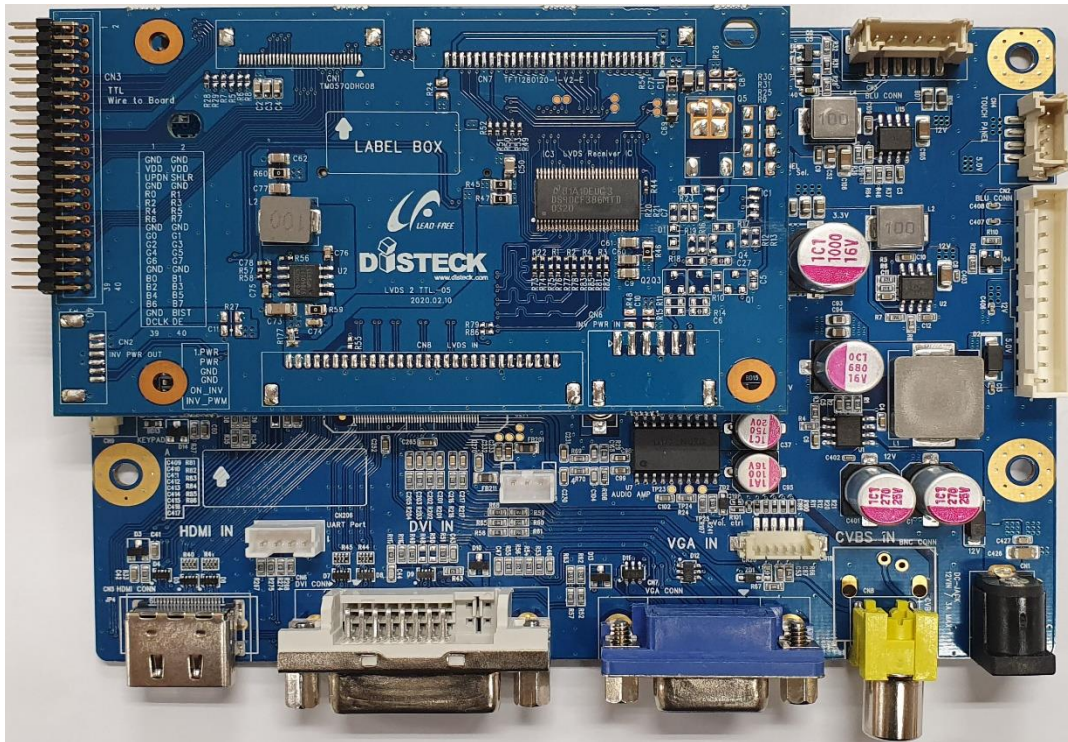

5. Dimension and Pictures - OSD Board

5.1 5Key OSD Board Type 1 : (108.9 x 19.5 mm)

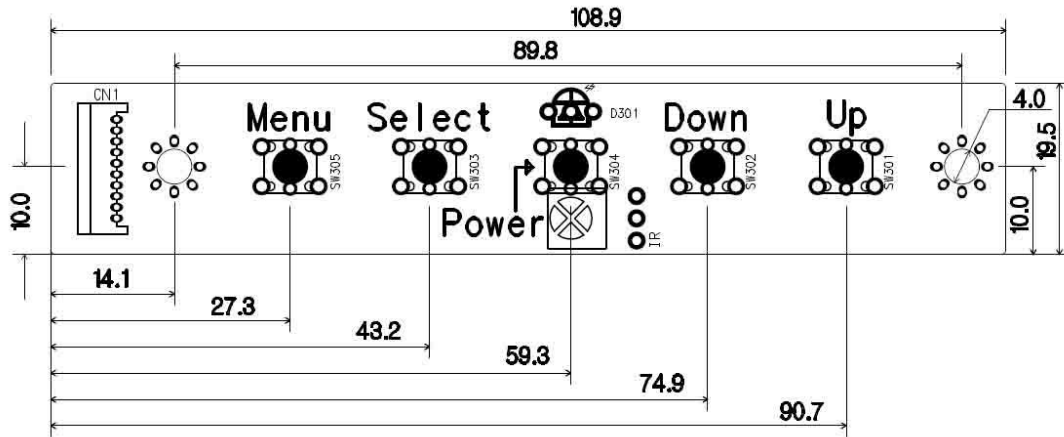

Standard model for board kit solution

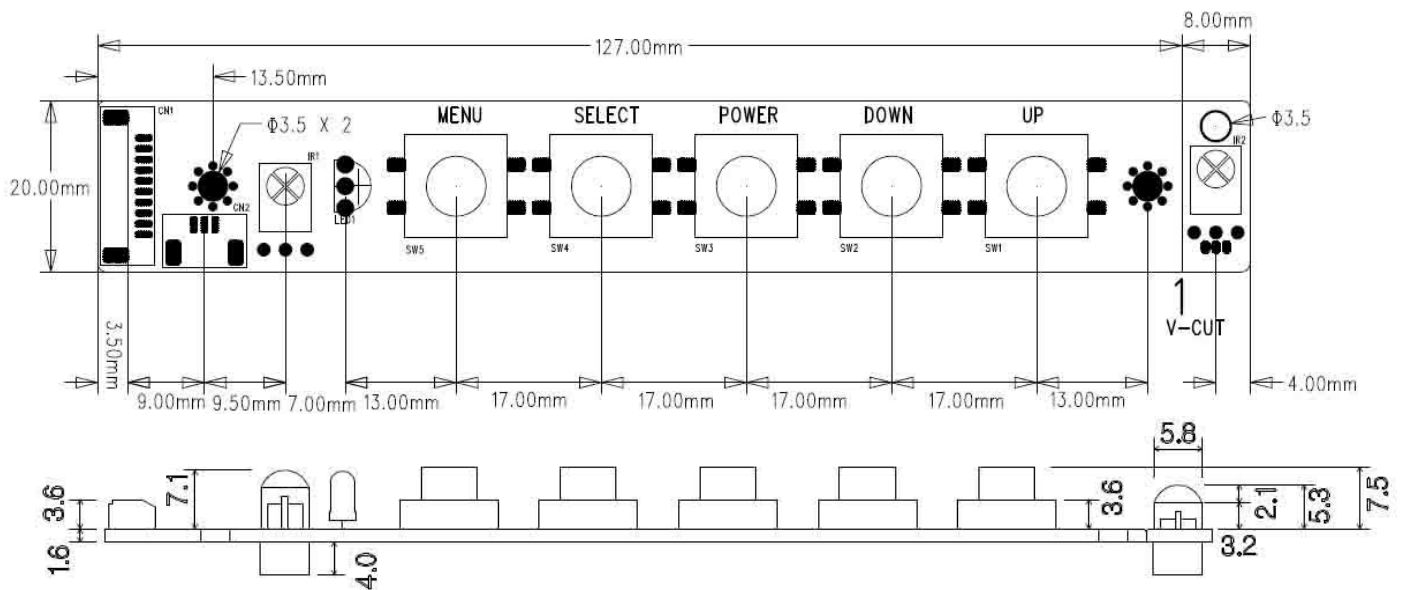
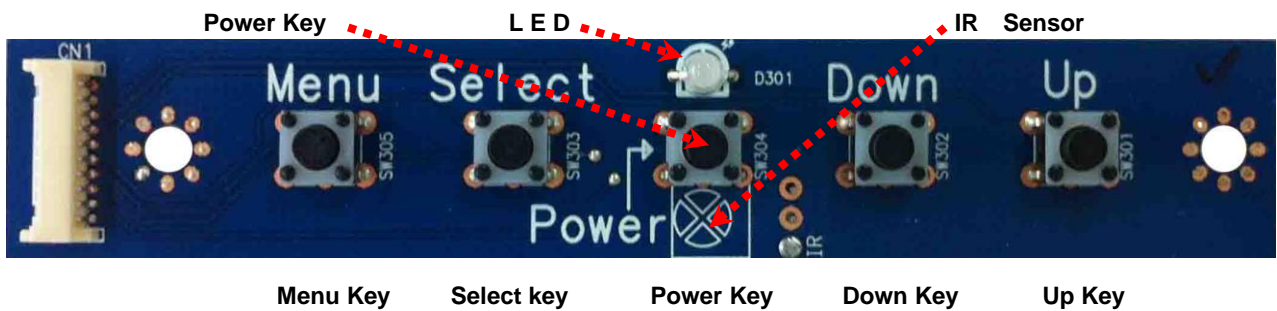

Option model for Open Frame or complete set solution

The OSD PCB consists of all in one type and split I/R sensor part.
In case of split type, the user can make it two different parts by cut easily.
(The border line between OSD body and split I/R sensor part was made by half cut condition)

All in one type - I/R Sensor and OSD PCB

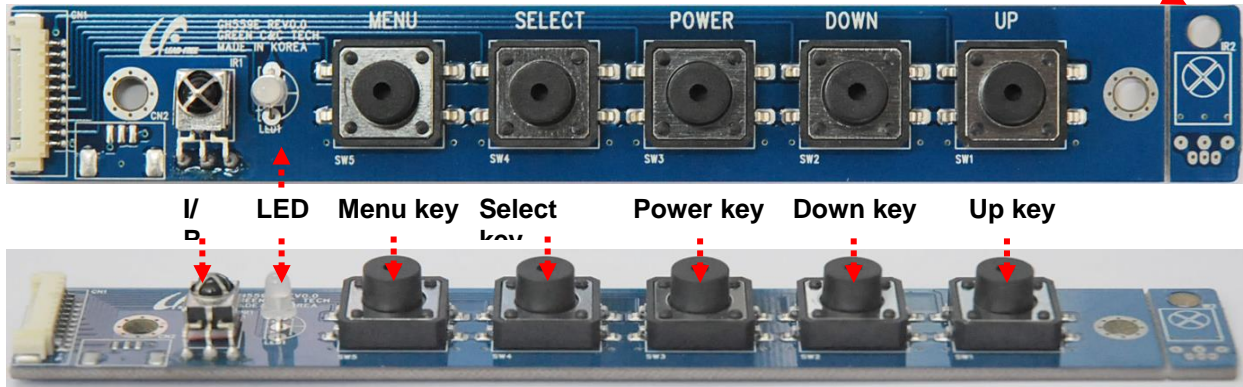

Split Type – separative I/R sensor

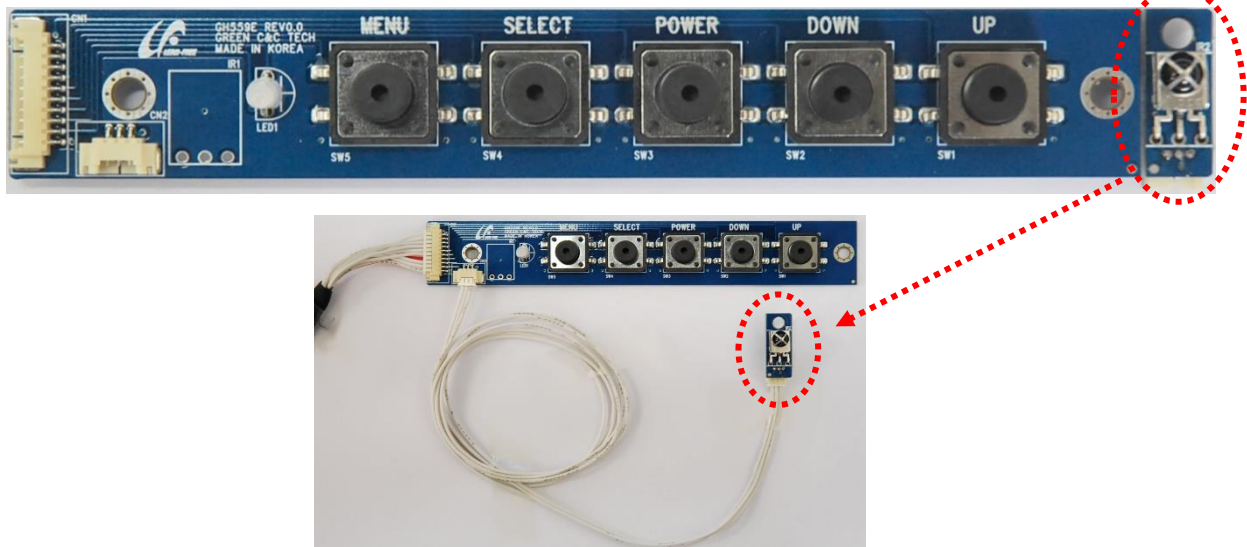

Laminate Sticker for fine finishing the open frame or complete set (option)

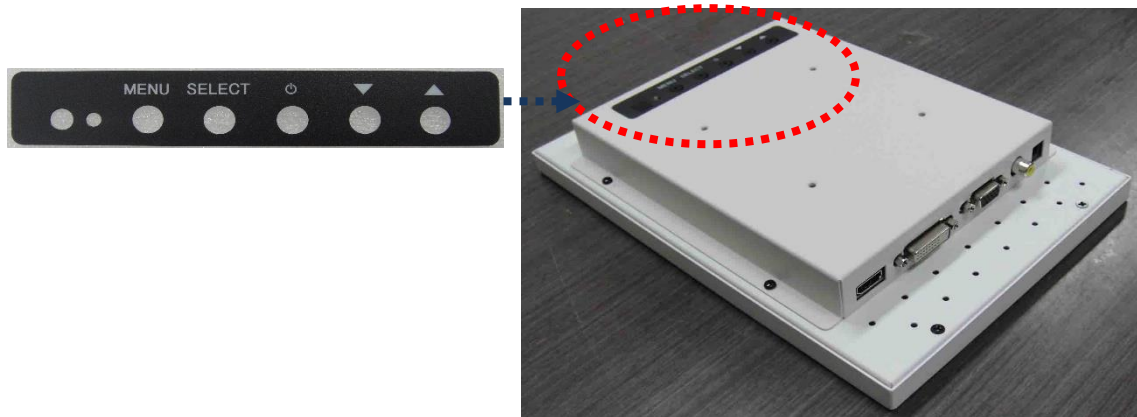

6. Connectors and Pin information

6.1 Connectors Summary

Service	Maker	Part number	Description	Point / Mating Housing
8-bit LVDS output	Yeon-Ho	12507WR-30P	1.25mm, 30p SMD	CN14 / 12507HS-30
Extra LVDS for 10-bit		12507WR-04P	1.25mm, 4p SMD	CN3 / 12507HS-0430
DVI IN		DVI 24+1, R/A	DVI-D, Right Angle	Standard DVI cable(Female)
HDMI IN		51L019S-333N	Right Angle	Standard HDMI cable(Female)
VGA		DB15	Right Angle	Standard VGA cable(Female)
C-VBS IN		RCA-102	Right Angle	Standard RCA cable(Female)
		BNC-P225		Standard BNC cable(Female)
RS232C I/F Wafer	Yeon-Ho	SMAW200-04	2.0mm, 4P, R/A	CN12 / SMH200-04
Inverter I/F	Yeon-Ho	SMAW200-06	2.0mm, 6P, R/A	CN3 / SMH200-06
OSD I/F	Yeon-Ho	12505WR-12	1.25mm, 12p SMD	CN13 / 12505HS-12
DC In (12V)	Yeon-Ho	DC-005(2.5PAI)		CN1 / DC Adapter
SMPS In (12V)	Yeon-Ho	SMW250-12	2.5mm, 12P, S/T	CN2 / SMH250-12
Touch Power (5V)	Yeon-Ho	SMAW200-04	2.0mm, 4P, R/A	CN4 / SMH200-04
Internal USB	Yeon-Ho	12505WR-08	1.25mm, 8p, SMD	CN11 / 12505HS-08
Audio Volume Control	Yeon-Ho	SMAW200-05	2.0mm, 5P, R/A	CN16 / SMH200-05
Speaker Out	Yeon-Ho	SMAW200-04	2.0mm, 4P, R/A	CN10 / SMH200-04
LVDS output(optional)	HIROSE	FX8C-60P-SV2	0.6mm, 60P SMD	CN17 / FX8C-60S-SV5
I2C Control / CDS	BTOB	BH254S-2525-04G-3060	2.54mm, 4P Pin Header	JP3 / CH254
UART Port	JST	PHR-04	2.0mm, 4P, DIP	CN206 / B4B-PH-K-S
Analog Audio-in Port	JST	PHR-03	2.0mm, 3P, DIP	CN208 / B3B-PH-K-S
Service Port	Yeon-Ho	12505WS-06	1.25mm, 6p, SMD	CN20 / 12505HS-06

[Optional Daughter Board adoption]

- 24V DC support : to be combined with the DC-DC Converter only
Refer to the Chapter 9. Appendix - A (Option : 24V DC Daughter board)

- TTL signal interface support : to be combined with a separate type daughter board
Refer to the Chapter 10, Appendix – B / LVDS Receiver board
(Option : the LVDS input and TTL output Daughter Board)

[Optional C-VBS Connector Selection]

User can select the type of C-VBS (Composite Video) input Jack between the ordinary RCA Jack style (Standard) and BNC type Connector, but the center line of relevant Jack type connector is the same.

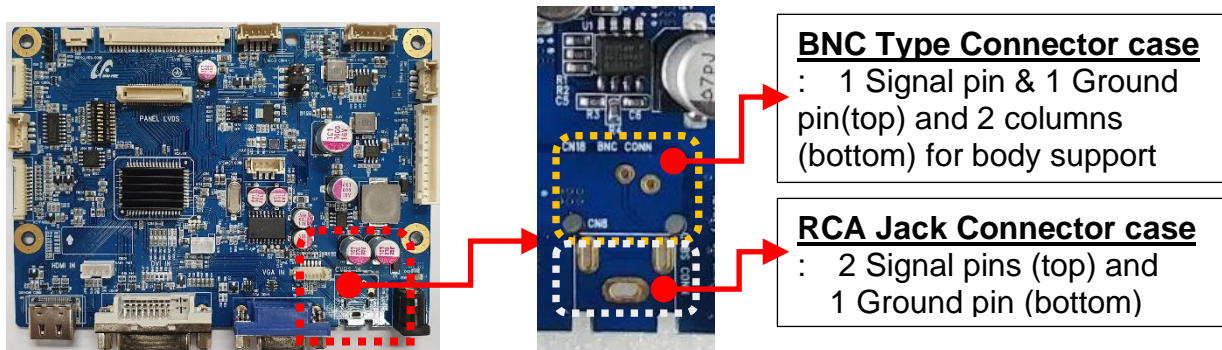

6.2 Pin Information Detail

6.2.1 8-bit LVDS output : LVDS 30Pin (12507WR-30P) / CN14

Pin No.	Function	Pin No.	Function	Pin No.	Function	Pin No.	Function	Pin No.	Function
1	Vcc	7	GND	13	TXE2-	19	TXE0-	25	TXO2+
2	Vcc	8	TXE3+	14	GND	20	TXO3+	26	TXO2-
3	Vcc	9	TXE3-	15	TXE1+	21	TXO3-	27	TXO1+
4	Note - 1	10	TXEC+	16	TXE1-	22	TXOC+	28	TXO1-
5	Note - 2	11	TXEC-	17	GND	23	TXOC-	29	TXO0+
6	NC	12	TXE2+	18	TXE0+	24	GND	30	TXO0-

[Note] These 1 & 2 : ordinary LVDS cabling needs to be NC but additional integration externally for LVDS → eDP Conversion or FRC circuit of 60Hz → 120Hz conversion, these pins can take charge of the MCU roles instead of separated MCU on the external conversion daughter board (Pin 4 : MCU_SCL, Pin 5 : MCU_SDA)

6.2.2 Extra LVDS output for 10-bit panel : LVDS 4Pin (12507WR-04P) / CN15

Pin No.	Function	Pin No.	Function	Pin No.	Function	Pin No.	Function
1	TXE4+	2	TXE4-	3	TXO4+	4	TXO4-

6.2.3 DVI Input (DVI D-Type)

Pin No.	Function	Pin No.	Function	Pin No.	Function	Pin No.	Function	Pin No.	Function
1	TX2-	6	DDC CLK	11	TX 1/3 Shield	16	H/P Detect	21	NC
2	TX2+	7	DDC data	12	NC	17	TX0 -	22	TXClk Shield
3	Data2/4 Shield	8	NC	13	NC	18	TX0 +	23	TXCLK+
4	NC	9	TX1-	14	DC +5V	19	TX0/5 Shield	24	TXCLK-
5	NC	10	TX1+	15	Ground	20	NC		

6.2.4 HDMI Input

Pin	Function	Pin	Function	Pin	Function	Pin	Function	Pin	Function
1	Data2 +	5	Data1 Shield	9	Data0 -	13	CEC	17	DDC/CEC GND
2	Data2 Shield	6	Data1 -	10	CLK +	14	NC	18	DC +5V
3	Data2 -	7	Data0 +	11	CLK Shield	15	DDC_SCL	19	HP Detect
4	Data1 +	8	Data0 Shield	12	CLK -	16	DDC_SDA		

6.2.5 VGA Input (D-SUB 15Pin)

Pin No.	Function	Pin No.	Function	Pin No.	Function	Pin No.	Function
1	Red	5	Check Signal	9	NC	13	HSYNC
2	Green	6	GND	10	GND	14	VSYSN
3	Blue	7	GND	11	NC	15	DDC_SCL
4	NC	8	GND	12	DDC_SDA		

6.2.6 RS232C Control : CN12 (SMW200-04)

Pin No.	Function	Pin No.	Function	Pin No.	Function	Pin No.	Function
1	RX	2	GND	3	TX	4	GND

6.2.7 C-VBS Input : (RCA Jack)

Pin No.	Function	Pin No.	Function
1	GND	2, 3	CVBS

C-VBS Input : (BNC Jack)

Pin No.	Function	Pin No.	Function
1	GND	2, 3, 4	CVBS

6.2.8 Inverter Interface : CN3 (SMAW200-06)

Pin No.	Function	Pin No.	Function	Pin No.	Function
1	+12V	3	GND	5	On/Off
2	+12V	4	GND	6	Dimmer

6.2.9 OSD Interface : CN9 (12505WR-12)

Pin No.	Function	Pin No.	Function	Pin No.	Function	Pin No.	Function
1	Menu	4	Power	7	NC	10	Ground
2	Select	5	Up	8	LED Green	11	5 V
3	Down	6	Function	9	LED Red	12	IR Data

6.2.10 12V DC In : (DC-005)

Pin No.	Function	Pin No.	Function	Pin No.	Function
1	+12V	2	Detect	3	GND

6.2.11 SMPS Interface : CN2 (SMW250-12)

Pin No.	Function	Pin No.	Function	Pin No.	Function	Pin No.	Function
1	+5V	4	GND	7	SMPS +12V	10	GND
2	+5V	5	GND	8	On/Off	11	Inverter Dimmer
3	Standby +5V	6	SMPS +12V	9	GND	12	Inverter On/Off

6.2.12 Touch Controller Power : CN4 (SMAW200-04)

Pin No.	Function	Pin No.	Function	Pin No.	Function	Pin No.	Function
1	+5V	2	+5V	3	GND	4	GND

6.2.13 Audio output & Control : CN16 (SMAW200-05)

Pin No.	Function	Pin No.	Function	Pin No.	Function
1	STAND-BY	2	Mute	3	VOL
4	LEFT-AUDIO	5	RIGHT-AUDIO		

6.2.14 internal USB : CN11 (12505WR-08)

Pin No.	Function	Pin No.	Function	Pin No.	Function	Pin No.	Function
1	+5V	2	D1-	3	D1+	4	GND
5	+5V	6	D0-	7	D0+	8	GND

6.2.15 I2C Extension(option) : JP3(1*3 2.54mm HEADER)

Pin No.	Function	Pin No.	Function	Pin No.	Function	Pin No.	Function
1	+3.3V	2	I2C_SDA	3	I2C_SCL	4	GND

6.2.16 Speaker for HDMI input: CN10 (SMAW200-04), 2W x 2W

Pin No.	Function	Pin No.	Function	Pin No.	Function	Pin No.	Function
1	Right	2	GND	3	Left	4	GND

6.2.17 LVDS Output(Optional) : CN17(FX8C-60P-SV2)

Pin	Function	Pin	Function	Pin	Function	Pin	Function	Pin	Function
1	TXO4-	13	TXO3-	25	ON_INV	37	TXE3+	49	TXOC+
2	TXO4+	14	TXO3+	26	DIM_INV	38	TXE3-	50	TXOC-
3	TXE4-	15	TXE0-	27	GND	39	TXEC+	51	TXO2+
4	TXE4+	16	TXE0+	28	GND	40	TXEC-	52	TXO2-
5	TXO0-	17	TXE1-	29	VPANEL	41	TXE2+	53	TXO1+
6	TXO0+	18	TXE1+	30	VPANEL	42	TXE2-	54	TXO1-
7	TXO1-	19	TXE2-	31	VPANEL	43	TXE1+	55	TXO0+

8	TXO1+	20	TXE2+	32	VPANEL	44	TXE1-	56	TXO0-
9	TXO2-	21	TXEC-	33	GND	45	TXE0+	57	TXE4+
10	TXO2+	22	TXEC+	34	GND	46	TXE0-	58	TXE4-
11	TXOC-	23	TXE3-	35	MCU_SCL	47	TXO3+	59	TXO4+
12	TXOC+	24	TXE3+	36	MCU_SDA	48	TXO3-	60	TXO4-

6.2.18 Service Port : CN20 (12505WS-06)

Pin No.	Function	Pin No.	Function	Pin No.	Function	Pin No.	Function
1	CVBS OUT	2	GPIO1	3	GPIO2	4	GPIO3
5	GPIO4	6	GND				

6.2.19 Analog Audio-In : CN208 (PHR-03)

Pin No.	Function	Pin No.	Function	Pin No.	Function	Pin No.	Function
1	AUDIO_IN_R	2	AUDIO_IN_L	3	GND		

6.2.20 UART Port : CN206 (PHR-04)

Pin No.	Function	Pin No.	Function	Pin No.	Function	Pin No.	Function
1	NC	2	GND	3	TX	4	RX

7. Setup for Operation

The OSD (On Screen Display) provides certain functions to have clear image and others. This board supports 5 buttons OSD Menu operation as a standard. The control functions defined on OSD operation are as below.

KEY OPERATION

MENU – Brings up OSD main menu, Hides OSD main menu, Cancels current adjustment.

SEL – Source Selection, Confirms current adjustment during OSD adjustment.

POWER – Power On/Off Key

UP – User Defined Feature, Increases adjustment

DOWN – User Defined Feature, Push and Hold for Auto Adjustment for VGA input, Decreases adjustment

7.1 Functions on OSD Menu

OSD MENU	Description
Picture Mode	Picture preset mode. (Standard, Dynamic, User, Mild)
Contrast	Adjust the contrast of the screen.
Brightness	Adjust the brightness of the screen.
Colour	Adjust the colour of the screen's image.
Sharpness	Adjust the sharpness of the screen's image.
Tint	Adjust the tint of the screen's image.
Color Temp	Adjust color temperature of the screen's image.
Backlight	Adjust the backlight of the screen.
H-Pos	Adjust the horizontal position of the screen's image
V-Pos	Adjust the vertical position of the screen's image
Clock	Adjust the horizontal size of the screen's image
Phase	Adjust the focus of the screen's image
Auto	Automatically adjust the Horizontal position, Vertical position, Window's background or characters should be displayed on your full screen prior to precede this function.
3D NR	Select NR mode. (Off, Strong, Standard, Weak)
Menu Language	Select the OSD language. (English / Русский / Italiano / Nederlands / Deutsch / Español / Française)
Transparency	Adjust the OSD transparency level. (0 ~ 5)
OSD Time Out	Define OSD time out. (Off, 5Sec, 10Sec, 15Sec)
Restore Default	Initializing that memory by factory presetting except OSD language.
Power Save	Adjust the Power Save time. (0 ~ 120Min)
Zoom Mode	Select the zoom mode. (Normal, OverScan, Zoom)
Image Flip	Image is reversed by vertical. (On, Off)
Image Mirror	Image is reversed by horizontal. (On, Off)
Auto Source	Detect the valid input source automatically. (On, Off)
Source	Select video input source using OSD or direct key in Remocon.

7.2 Hot Key

There are some hot keys are reserved for users' convenience as follows.

Pressing method the buttons	Function
Push and Hold for Auto Adjustment for VGA input	Auto Adjust
Press UP key will bring up Backlight	Brings up Backlight adjustment
Press DOWN key will bring up Volume adjustment. Use UP/DOWN key for adjustment.	Brings up Volume adjustment

7.3 Menu Selection on the OSD Menu

There are 2 kinds of OSD Menu selections

- by the Remote Controller (optional accessory)



When user uses the remote controller, press the “source ” button, then the below “Input Source” windows comes up on the right top of screen. Then, whatever user need to settle the activation among the 4 kinds of input signal.

ex : see below picture

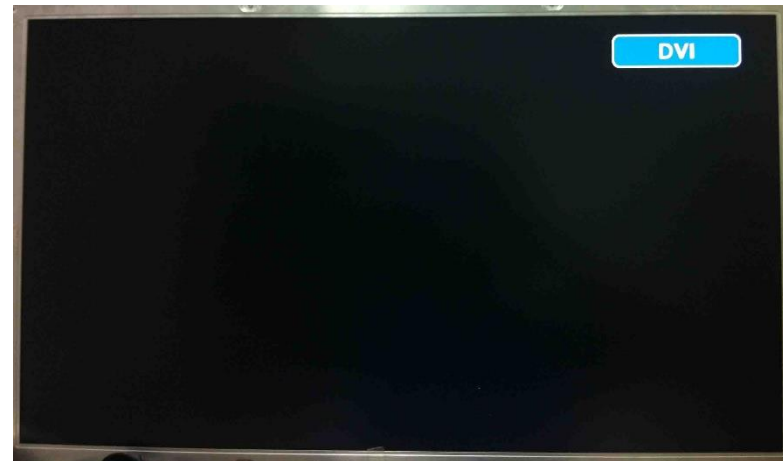

7.4. OSD Menu Tree

The signal source selection:

- Press the “Set” button on the OSD Board or Press the Remote Controller (RGB, DVI, HDMI, CVBS)
- When user activates the “Auto Color” menu, there must be existed the black and white clearly as background image.
(the most easiest condition : please use the Auto Color menu when the background image is opened the MS-Word or Excel file on the screen)

7.4.1 Picture Menu

The right pictures are the first menu “Picture” and the sub menu details of “Color Temp”

Icon	Main Menu	Sub menu	
	Picture	Applied the signal source for RGB (VGA input) and/or DVI	
	RGB	Picture Mode, Contrast, Brightness, Colour, Sharpness, Tint, Color Temp, Backlight, Auto Colour	
	DVI	Picture Mode, Contrast, Brightness, Colour, Sharpness, Tint, Color Temp, Backlight	
	Picture Mode	Standard / Dynamic / User / Mild	
	Contrast	0 ~ 100	
	Brightness	0 ~ 100	
	Colour	0 ~ 100	
	Sharpness	0 ~ 100	
	Tint	0 ~ 100	
	Color Temp	Color Mode	Warm / Medium / Cool / User
		Red	0 ~ 255
		Green	0 ~ 255
		Blue	0 ~ 255
Backlight	0 ~ 100		
Auto Color			

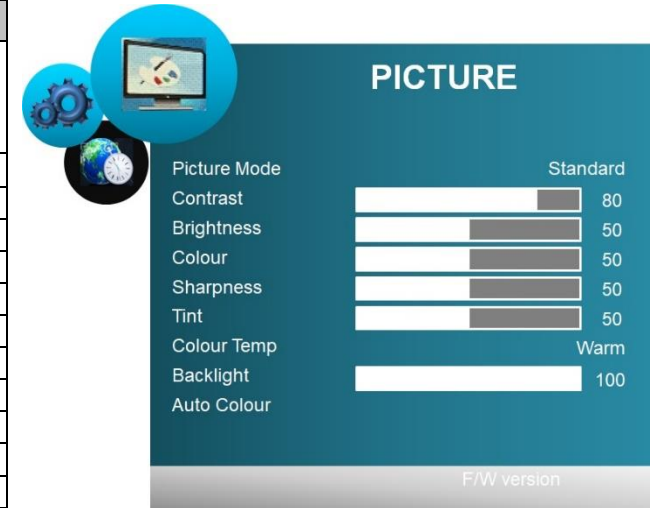

Icon	Main Menu	Sub menu	
	Picture	Applied the signal source for C-VBS and/or HDMI	
	C-VBS & HDMI	Picture Mode, Contrast, Brightness, Colour, Sharpness, Tint, Color Temp, Backlight	
	Picture Mode	Standard / Dynamic / User / Mild	
	Contrast	0 ~ 100	
	Brightness	0 ~ 100	
	Colour	0 ~ 100	
	Sharpness	0 ~ 100	
	Tint	0 ~ 100	
	Color Temp	Color Mode	Warm / Medium / Cool / User
		Red	0 ~ 255
		Green	0 ~ 255
		Blue	0 ~ 255
	Backlight	0 ~ 100	

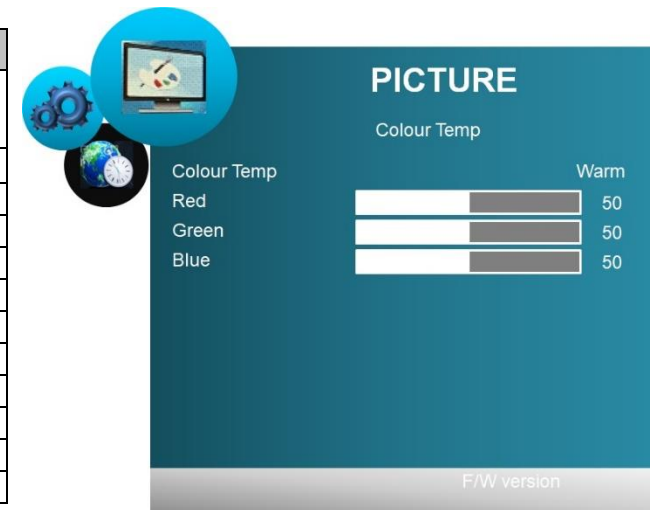

7.4.2 Option Menu

On the right “Option” menu,
When user goes into the “Source Setting” User can see the window like table menu

Icon	Main Menu	Sub menu
Option : Common Function		
	Menu Language	English / Русский / Italiano / Nederlands / Deutsch / Español / Française
	Transparency	0~5
	OSD Time Out	Off, 5, 10, 15 (Sec)
	OSD Info	ON / OFF
	Source Setting	CVBS / HDMI / DVI / RGB : “ ON ” or “ OFF ” respectively
	MUTE	ON / OFF
	Volume	0~100
	Restore Default	Yes / No

[Note]

Enabled sources from Source Setting can be searched via “Auto Source” mode.
Source Setting does NOT affect Manual Source Selection.

“OSD Info” suppresses all OSD output when an application requires silent operation.

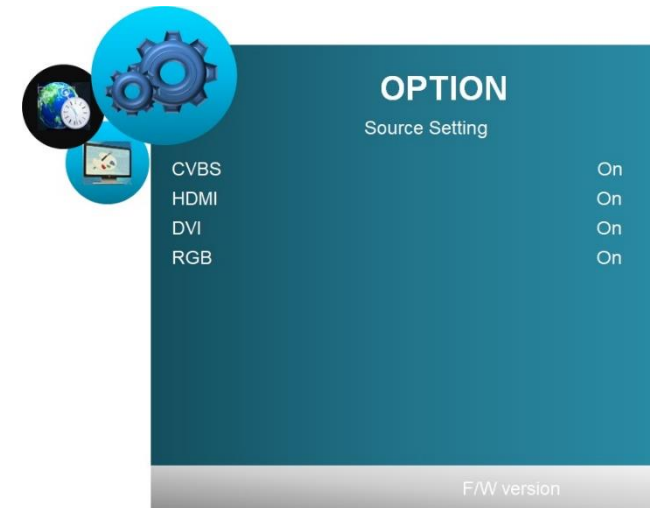
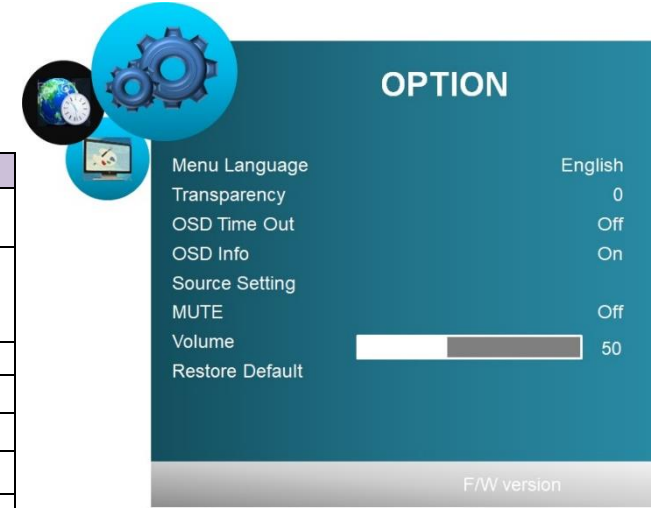

7.4.3 Function Menu

On the right “Function” menu,
When user goes into the “Advanced”
User can see the window like right shape menu.

Icon	Main Menu	Sub menu
	Function : Common Function	
	RGB : Power Save, Zoom Mode, Aspect, Image Flip, Image Mirror, Auto Source, 3DNR, Advanced	
	DVI & HDMI & CVBS : Power Save, Zoom Mode, Aspect, Image Flip, Image Mirror, Auto Source, 3DNR	
	Power Save	Off ~ 120 min.(off, 0.5, 1, 2, 5, 10, 30, 60, 120)
	Zoom Mode	Normal / OverScan / Zoom
	Aspect	Auto / 16 : 9 / 4 : 3 / Fill
	Image Flip	On / Off
	Image Mirror	On / Off
	Auto Source	On / Off
	3DNR	Off / Strong / Standard / Weak
	Advanced	H-pos 0 ~ 100
	V-pos 0 ~ 100	
	Clock 0 ~ 100	
	Phase 0 ~ 100	
	Auto Auto Adjust	

[Note]

The details of above **Zoom Mode** are :

- “ Over Scan “ mode : this is the factory default condition in general, most of target video sizes on the LCD screen mean this mode (5% zoom and cropped) Traditional CVBS input signal requires OverScan mode for general usage.
- “ Normal “ : Displays all available pixels into screen without cropping and zooming.
- “ Zoom “ : Magnifies center of screen by 25%

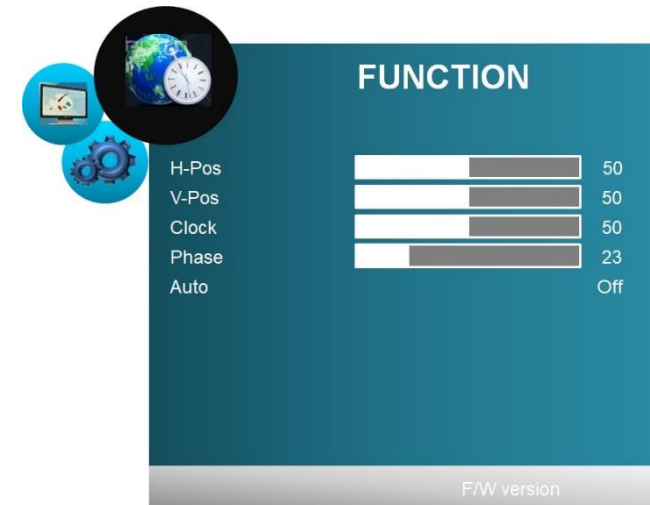
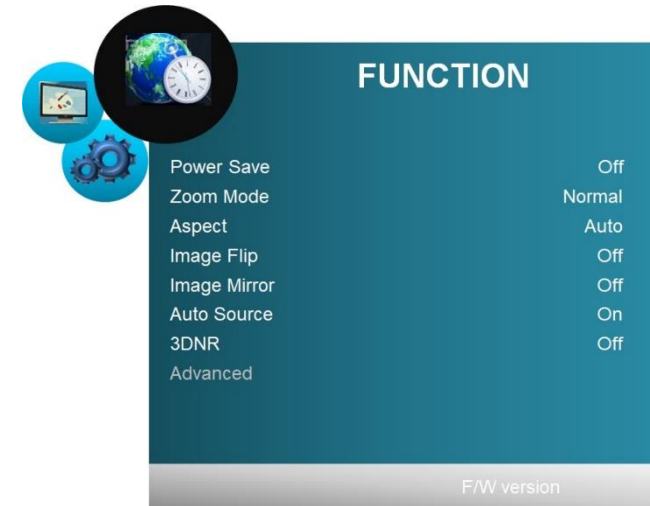

7.4.4 Setup Menu

[Note]

4 kinds of **User HotKey Setting** : this is a very convenient way of user choice in order to use the “Remocon (Remote Controller)” How can all users settle this function?

- Menu → SETUP → User Assign

then can be selected through the Keypad Up and Keypad Down button on OSD Board

The F1 ~ F4 are selectable a required function as the HotKey among all the menu among “Backlight, Volume, Contrast, Flip/Flop, Image Flip, Image Mirror, Mute, Mono, Colour Channel, Red Only, Green Only, Blue Only, Zoom”

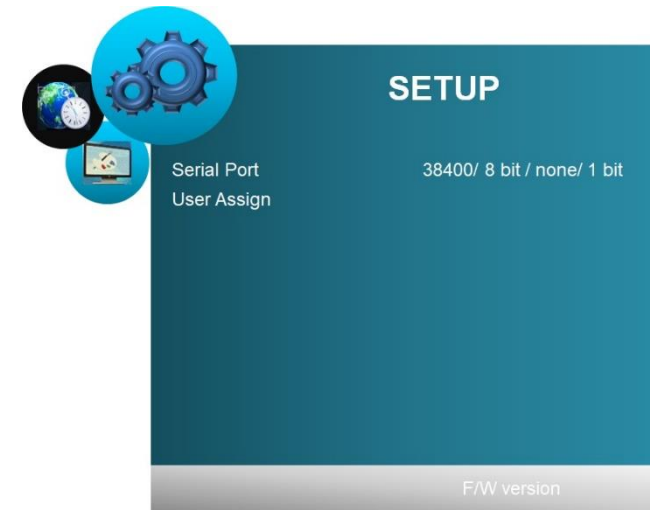

Icon	Main Menu	Sub menu		
Setup : Common Function				
	Serial Port	Baud Rate	1200 ~ 57600	
		Data	5bit ~ 8bit	
		Parity	None / Odd / Even	
		Stop	1bit	
	User Assign	KeyPad Up	Backlight, Volume, Contrast, Flip/Flop, Image Flip, Image Mirror, Mute, Mono, Colour Channel, Red Only, Green Only, Blue Only, Zoom	
		KeyPad Down	Backlight, Volume, Contrast, Flip/Flop, Image Flip, Image Mirror, Mute, Mono, Colour Channel, Red Only, Green Only, Blue Only, Zoom	
		F1	Backlight, Volume, Contrast, Flip/Flop, Image Flip, Image Mirror, Mute, Mono, Colour Channel, Red Only, Green Only, Blue Only, Zoom	
		F2	Backlight, Volume, Contrast, Flip/Flop, Image Flip, Image Mirror, Mute, Mono, Colour Channel, Red Only, Green Only, Blue Only, Zoom	
		F3	Backlight, Volume, Contrast, Flip/Flop, Image Flip, Image Mirror, Mute, Mono, Colour Channel, Red Only, Green Only, Blue Only, Zoom	
		F4	Backlight, Volume, Contrast, Flip/Flop, Image Flip, Image Mirror, Mute, Mono, Colour Channel, Red Only, Green Only, Blue Only, Zoom	

8. Applicable Graphic Mode

The microprocessor measures the H-sync, V-sync and V-sync/H-sync polarity for RGB inputs, and uses this timing information to control all of the display operation to get the proper image on a screen.

This board can detect all VESA standard and MAC Graphic modes shown on the table below and provide more clear and stable image on a screen.

● Table : RGB Input format

Mode \ Spec.	Pixel Freq.		Horizontal Timing				Vertical Timing			
			Sync Polar	Freq.	Total	Active	Sync Polar	Freq.	Total	Active
	MHz		KHz	Pixel	Pixel		Hz	Line	Line	
640x350 @70Hz	25.144	VESA	P	31.430	800	640	N	70.000	449	350
720x400 @70Hz	28.287	VESA	N	31.430	900	720	P	70.000	449	400
640x480 @60Hz	25.175	MAC	N	31.469	800	640	N	59.940	525	480
640x480 @60Hz	25.175	VESA	N	31.469	800	640	N	59.940	525	480
640x480 @67Hz	30.240	MAC	N	35.000	864	640	N	66.667	525	480
640x480 @72Hz	31.500	VESA	N	37.861	832	640	N	72.809	520	480
640x480 @75Hz	31.500	VESA	N	37.500	840	640	N	75.000	500	480
832x624 @75Hz	57.284	MAC	N	49.726	1152	832	N	74.551	667	624
800x600 @56Hz	36.000	VESA	P	35.156	1024	800	P	56.250	625	600
800x600 @60Hz	40.000	VESA	P	37.879	1056	800	P	60.317	628	600
800x600 @72Hz	50.000	VESA	P	48.077	1040	800	P	72.188	666	600
800x600 @75Hz	49.500	VESA	P	46.875	1056	800	P	75.000	625	600
1024x768 @60Hz	65.000	VESA	N	48.363	1344	1024	N	60.005	806	768
1024x768 @60Hz	64.000	MAC	N	48.780	1312	1024	N	60.001	813	768
1024x768 @70Hz	75.000	VESA	N	56.476	1328	1024	N	70.070	806	768
1024x768 @75Hz	80.000	MAC	N	60.241	1328	1024	N	74.927	804	768
1024x768 @75Hz	78.750	VESA	P	60.023	1312	1024	P	75.030	800	768
1280x768 @60Hz	79,500	VESA	P	47,780	1664	1280	P	59,870	798	768
1280x1024 @60Hz	108.000	VESA	P	63.981	1688	1280	P	60.020	1066	1024
1280x1024 @75Hz	135.000	VESA	P	79.976	1688	1280	P	75.025	1066	1024
1360X768 @60Hz	85.00	VESA	P	47.712	1792	1360	P	60.015	795	768
1600x1200 @60Hz	160.875	VESA	N	74.479	2160	1600	P	59.967	1242	1200
1680x1050 @60Hz	147.000	VESA	N	65.160	2256	1680	P	59.944	1087	1050
1920x1080 @60Hz	172.750	VESA	N	67.061	2576	1920	P	59.983	1118	1080
1920X1200@60Hz	193.125	VESA	N	74.508	1292	1920	P	59,990	1242	1200

9. Appendix - A (Option : 24V DC Power Board)

This is an optional daughter board which can support the direct power supply (24V DC) from a SMPS or System Power, then discharges the 12V DC to AD card or similar devices and the 24V DC by-pass to backlight of LCD display directly.

Electrical Characteristics

Item Description	Symbol / Mating Connector	Electrical Spec.			Unit
		Min	Typ	Max	
Input Voltage	V_{in} J5, J6 DC IN	21.6	24	26.4	Vdc
Input Current	I_{in} J5, J6 DC IN	-	-	6.3	Adc
Output Voltage	V_o J2 DC OUT	10.8	12	13.2	Vdc
Input Current	I_o J2 DC OUT	-	-	4	Adc

9.1 Block Diagram

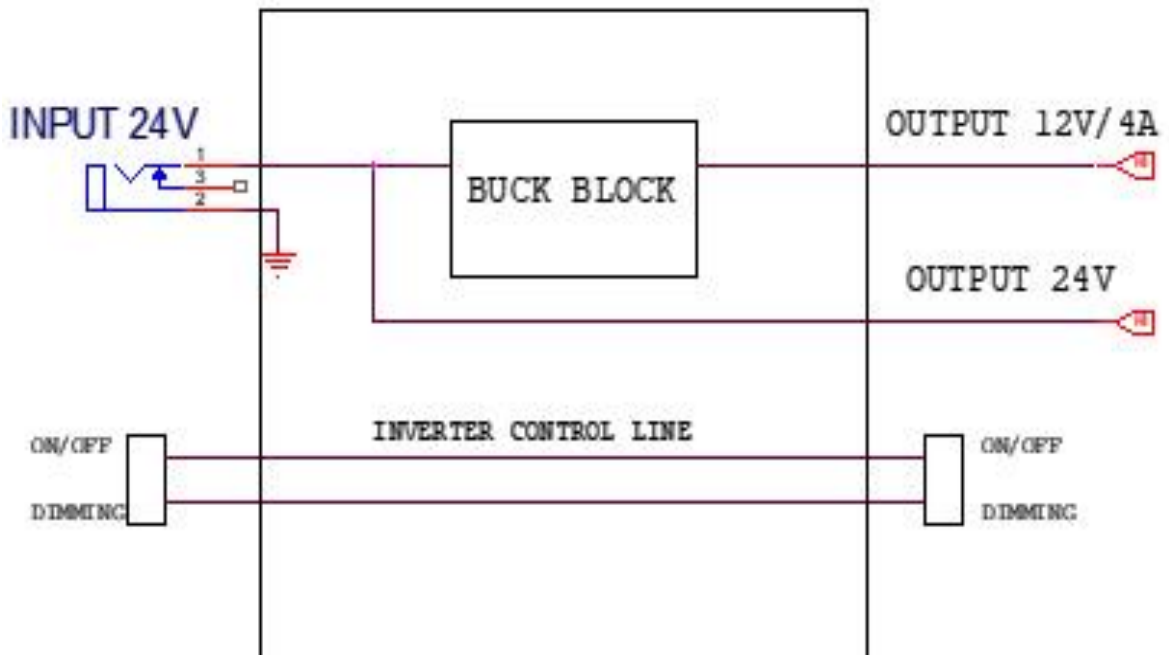

9.2 Dimension and Picture (90x45 mm)

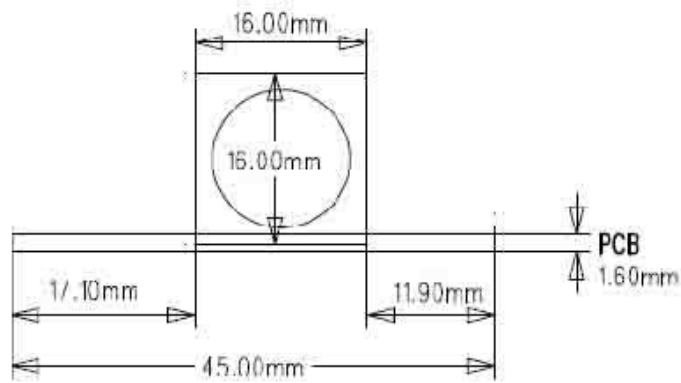
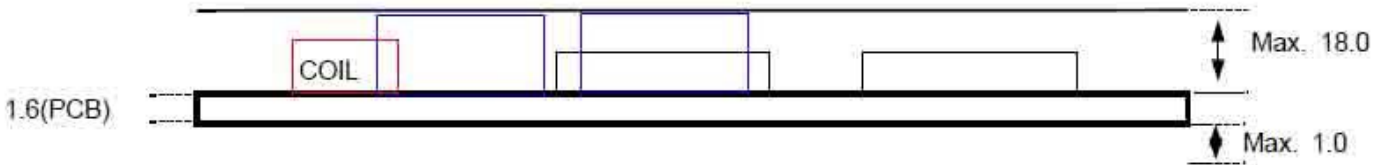
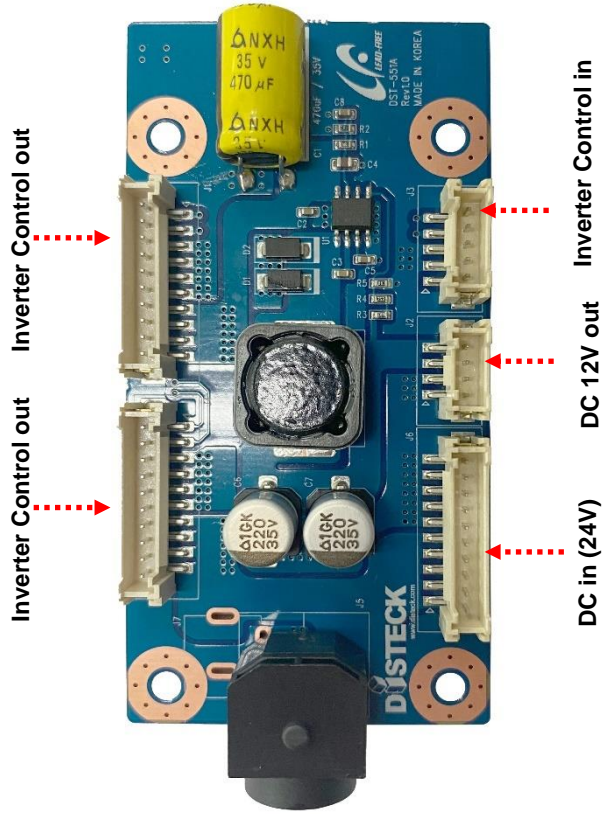
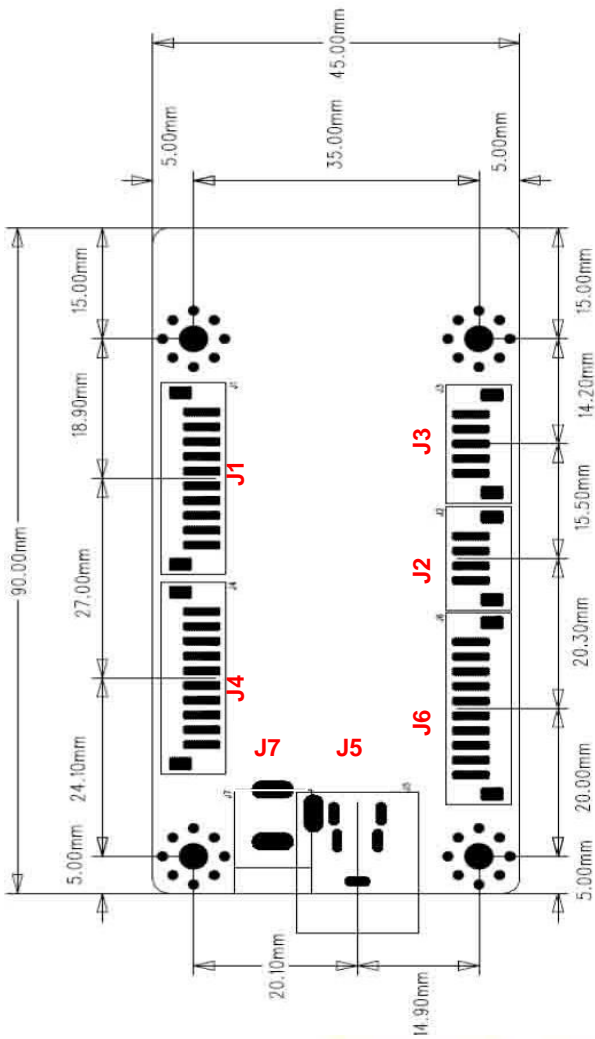

9.3 Pin Information

9.3.1 J1 & J4 / Inverter Control output Connector SMW200-H10G / Yeon-Ho

Pin No	Symbol	Pin No	Symbol	Pin No	Symbol	Pin No	Symbol
1	Inv. On / Off	2	Dimming	3 ~ 6	GND	7 ~ 10	24V

9.3.2 J3 / Inverter Control input Connector SMW200-H05G / Yeon-Ho

Pin No	Symbol	Pin No	Symbol	Pin No	Symbol	Pin No	Symbol
1	N.C.	2 ~ 3	GND	4	Dimming	5	Inv. On / Off

9.3.3 J2 / 12V DC Output Connector SMW200-H04G / Yeon-Ho

Pin No	Symbol	Pin No	Symbol	Pin No	Symbol	Pin No	Symbol
1	GND	2	GND	3	12V	4	12V

9.3.4 J5 / 24V DC Jack Connector DIN-422(BSUN) / Yeon-Ho

Pin No	Symbol	Pin No	Symbol	Pin No	Symbol	Pin No	Symbol
1	+24V	2	GND	3	+24V	4	GND

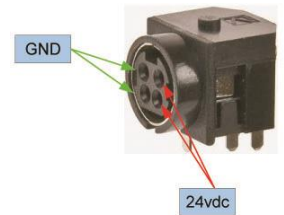

9.3.5 J6 / 24V DC Power Input Connector SMW200-H10G / Yeon-Ho

Pin No	Symbol	Pin No	Symbol
1 ~ 5	24V	6 ~ 10	GND

9.3.6 J7 / 24V DC Power Input Jack (round type) / Yeon-Ho

Pin No.	Function	Pin No.	Function	Pin No.	Function
1	+12V	2	Detect	3	GND

10. Appendix - B (Option : LVDS Receiver board)

10.1 Top View

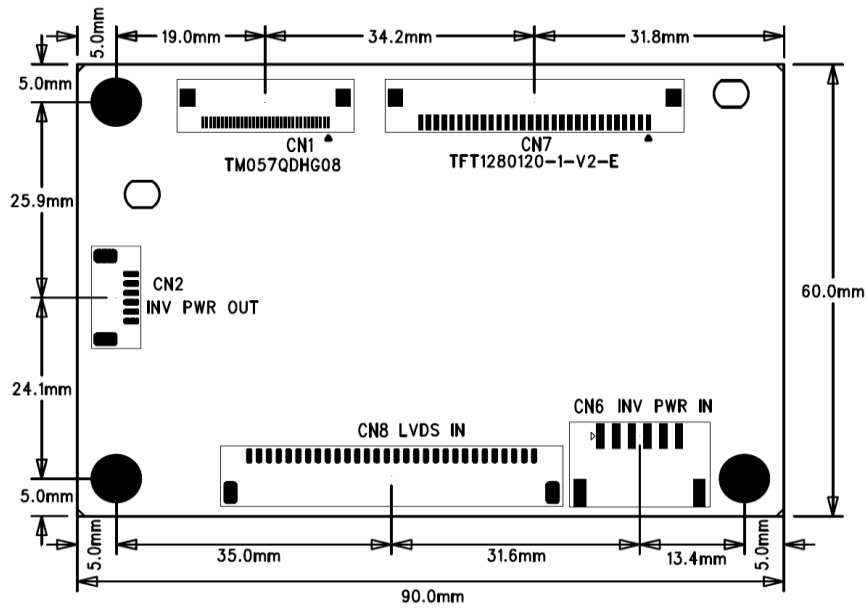

10.2 Bottom View

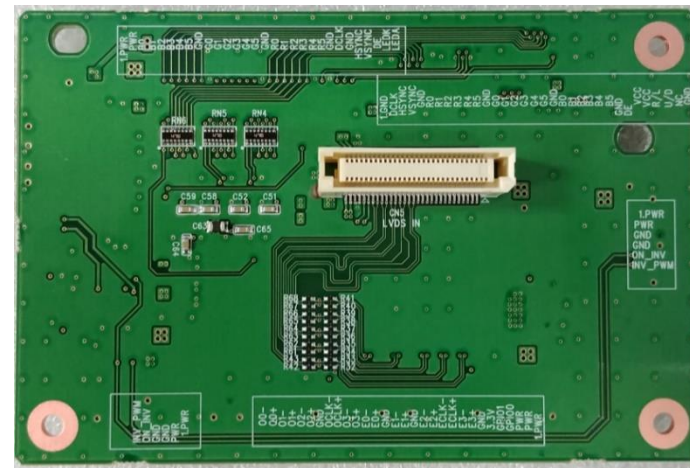
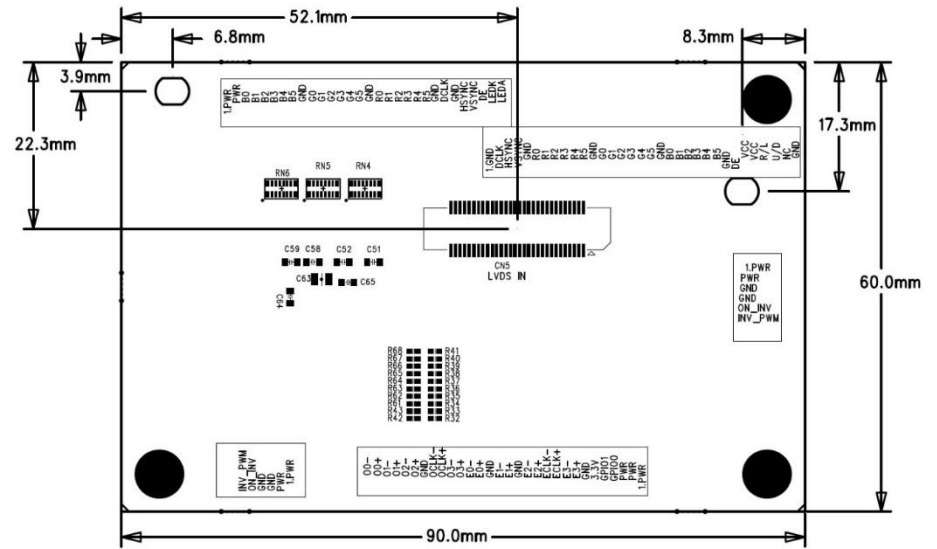

10.3 Pin Information

10.3.1 CN1 TTLout FPC 33P(0.5mm Pitch)

Pin	Function	Pin	Function	Pin	Function	Pin	Function	Pin	Function
1	GND	8	R2	15	G2	22	B2	29	VCC
2	PCLK	9	R3	16	G3	23	B3	30	R/L
3	HSYNC	10	R4	17	G4	24	B4	31	U/D
4	VSYNC	11	R5	18	G5	25	B5	32	NC
5	GND	12	GND	19	GND	26	GND	33	GND
6	R0	13	G0	20	B0	27	DE		
7	R1	14	G1	21	B1	28	VCC		

10.3.2 CN7 TTLout FPC 30P(1mm Pitch)

Pin	Function	Pin	Function	Pin	Function	Pin	Function	Pin	Function
1	VCC	7	B4	13	G3	19	R2	25	GND
2	VCC	8	B5	14	G4	20	R3	26	HSYNC
3	B0	9	GND	15	G5	21	R4	27	VSYNC
4	B1	10	G0	16	GND	22	R5	28	DE
5	B2	11	G1	17	R0	23	GND	29	LEDK
6	B3	12	G2	18	R1	24	DCLK	30	LEDA

10.3.3 CN5 LVDS IN

Pin	Function	Pin	Function	Pin	Function	Pin	Function	Pin	Function
1	TXO4-	13	TXO3-	25	ON_INV	37	TXE3+	49	TXOC+
2	TXO4+	14	TXO3+	26	DIM_INV	38	TXE3-	50	TXOC-
3	TXE4-	15	TXE0-	27	GND	39	TXEC+	51	TXO2+
4	TXE4+	16	TXE0+	28	GND	40	TXEC-	52	TXO2-
5	TXO0-	17	TXE1-	29	VPANEL	41	TXE2+	53	TXO1+
6	TXO0+	18	TXE1+	30	VPANEL	42	TXE2-	54	TXO1-
7	TXO1-	19	TXE2-	31	BLU_VIN	43	TXE1+	55	TXO0+
8	TXO1+	20	TXE2+	32	BLU_VIN	44	TXE1-	56	TXO0-
9	TXO2-	21	TXEC-	33	GND	45	TXE0+	57	TXE4+
10	TXO2+	22	TXEC+	34	GND	46	TXE0-	58	TXE4-
11	TXOC-	23	TXE3-	35	MCU_SCL	47	TXO3+	59	TXO4+
12	TXOC+	24	TXE3+	36	MCU_SDA	48	TXO3-	60	TXO4-

10.3.4 CN6 PWR IN

Pin No	Symbol	Pin No	Symbol	Pin No	Symbol
1	VCC	3	GND	5	ON/OFF
2	VCC	4	GND		DIM

10.3.5 CN2 PWR OUT

Pin No	Symbol	Pin No	Symbol	Pin No	Symbol
1	VCC	3	GND	5	ON/OFF
2	VCC	4	GND		DIM

11. Appendix - C (Option : **Service Menu**) – only for system integrator

- **Service Menu Setting**

This is the manual for all system integrators, not the final users.
 Therefore the supplied final product do not show this menu as a standard product menu.
 In other words, this is a hidden menu for finish product manufacturers only.

How can a system integrator go into this menu?
 Press the OSD Buttons continuously – none stop pressing correctly as below

Menu → Down → Down → Down → Up → Up → Up → Down → Up → Down → Select



Icon	Main Menu	Sub menu	
Option : Common Function			
	Backlight Settings	Min	0 ~ 66668
		Max	0 ~ 69999 (Varies by frequency) Always keep maximum value for maximum brightness
		Control	Linear / Curve
		Invert	ON / OFF
		Frequency	120Hz ~ 500KHz

[Note]

“Max” can be used for limiting maximum brightness where power consumption limitation is required.

- How can user settle the Analog type dimming control under Analog Dimming type LED Driver?

Firstly to go into the Service Menu
 Secondly to settle all parameters as below condition

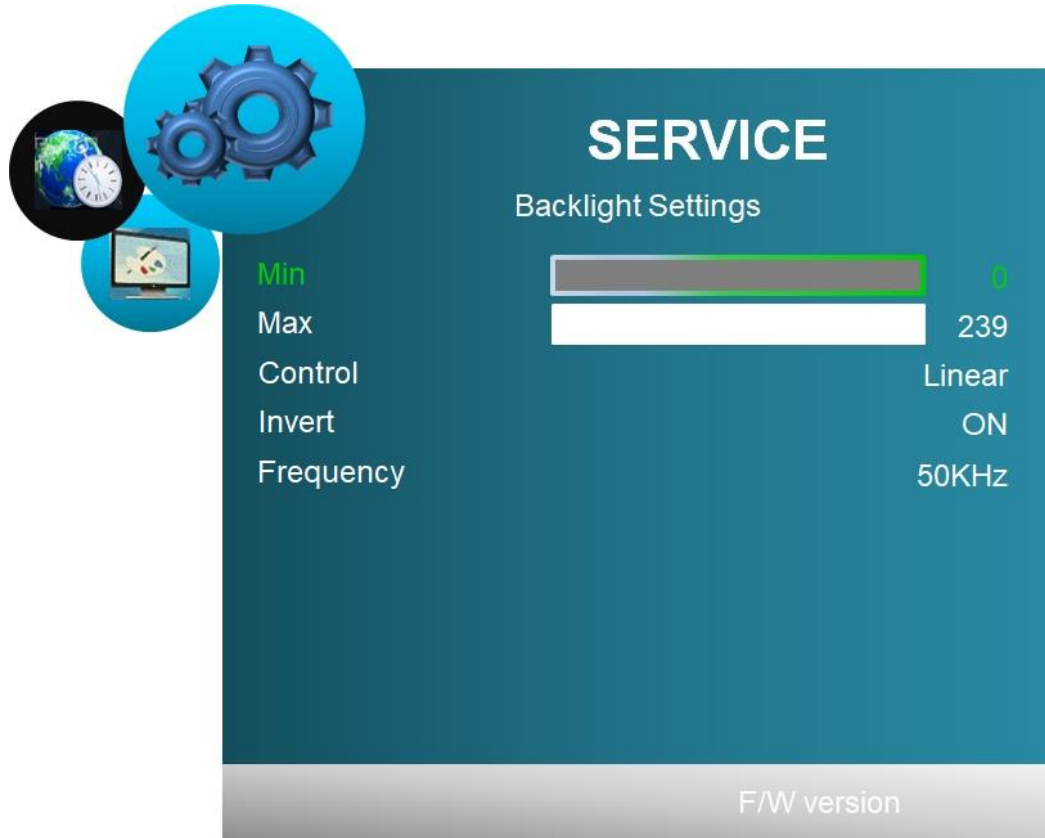

If not, the brightness level will be very lower than the spec of LCD.

For Analog dimming, PWM Frequency should be high enough to be integrated by RC components. We recommend from 20KHz to 50KHz by application requirement.

If backlight control value is backward from the actual brightness, use “Invert” mode.

Service MENU	Description
Min, Max	Setting this depending the level of PWM Duty on the target LCD Spec
Control	Setting of Gamma Curve of target LCD Spec
Invert	Setting of Dimming orientation depending on the target LCD Backlight setting
Frequency	Setting the PWM Frequency in accordance with the spec of target LCD Panel Recommended for 60Hz video world = 180Hz (Digital PWM mode only) Recommended for 50Hz video world = 150Hz (Digital PWM mode only)

12. Appendix - C (Option : RS232C Protocols)

12.1 RS-232 Serial control

- Baud rate : **38400**
- Data bit : 8 bits
- Stop bit : 1
- Parity bit : No

12.2 Physical connection

Controller side:
 Connector interface: CN8
 Mating connector: DB9 Female or
 20010HS-04, Yeon-Ho

Computer side:
 Connector interface: Serial port
 Mating connector: DB9 Male

PIN#	Description
1	RS-232 Rx Data
2	Ground
3	RS-232 Tx Data
4	Ground

PIN#	Description
2	RS-232 Rx Data
3	RS-232 Tx Data
5	Ground

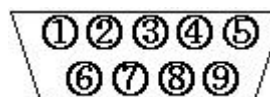
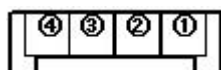

12.3 RS-232 Serial Protocols

Command	Header (1)	Command (1)	*Data Type (1)	*Data (1)		*Check (1)	
Remocon Function	Request 0xAA	0x01	0x00	*Key Code		-	
Audio Volume		0x02	0x00: Value 0x80: Decrease by 1 0x81: Increase by 1 0xFF: Data Read	0x00 ~ 0x64	0 ~ 100		
Power		Response 0x55	0x03	0x00: Value 0xFF: Status Read	0x00	Power On	-
					0x0A	Power Off	-
					0xFF	Status Read	-
Picture Mode		0x10	0x00: Value 0x80: Decrease by 1 0x81: Increase by 1 0xFF: Data Read	0x00 0x01 0x02 0x03	Standard Dynamic Soft Personal	-	
Contrast		0x11		0x00 ~ 0x64	0 ~ 100	-	
Brightness		0x12		0x00 ~ 0x64	0 ~ 100	-	
Sharpness		0x13		0x00 ~ 0x64	0 ~ 100	-	
Tint		0x14		0x00 ~ 0x64	0 ~ 100	-	

Command	Header (1)	Command (1)	*Data Type (1)	*Data (1)		*Check (1)
Color		0x15		0x00 ~ 0x64	0 ~ 100	-
Color Mode		0x16		0x00 0x01 0x02 0x03	Normal Warm Cool User	
Color Red		0x17		0x00 ~ 0xFF	0 ~ 255	
Color Green		0x18		0x00 ~ 0xFF	0 ~ 255	
Color Blue		0x19		0x00 ~ 0xFF	0 ~ 255	
3DNR		0x1A		0x00 0x01 0x02 0x03	Off Weak Standard Strong	-
Backlight		0x1B		0x00 ~ 0x64	0 ~ 100	
Auto Color		0x1C		0x00	0x00	Execution
Adv. H-Position	Request 0xAA Response 0x55	0x20	0x80: Decrease by 1 0x81: Increase by 1 0xFF: Data Read	0x00 ~ 0x64	0 ~ 100	-
Adv. V-Position		0x21		0x00 ~ 0x64	0 ~ 100	-
Adv. Clock		0x22		0x00 ~ 0x64	0 ~ 100	-
Adv. Phase		0x23		0x00 ~ 0x64	0 ~ 100	-
Adv.Auto		0x24	0x00	0x00	Execution	
OSD Menu Status		0x3F	0xFF	0xFF	*Menu Status	

Command	Header (1)	Command (1)	*Data Type (1)	*Data (1)		*Check (1)			
Menu Language	Request 0xAA	0x40	0x00: Value 0x80: Decrease by 1 0x81: Increase by 1 0xFF: Data Read	0x00	English				
				0x01	French				
				0x02	Spanish				
				0x03	Deutsch				
				0x04	Nederland				
				0x05	Italiano				
				0x06	Russian				
Transparency		Response 0x55		0x41	0x00: Value 0x80: Decrease by 1 0x81: Increase by 1 0xFF: Data Read		0x00	0%	
			0x01	25%					
			0x02	50%					
			0x03	75%					
			0x04	100%					
OSD Time Out			0x42	0x00		0x00	Off		
						0x01	5 Sec.		
			0x02		15 Sec.				
Restore Default		0x43	0x00	0x00	Execution				
CVBS Source Setting		0x44	0x00: Value 0x80: Decrease by 1 0x81: Increase by 1 0xFF: Data Read	0x00	Off				
HDMI Source Setting		0x45							
DVI Source Setting		0x46							
RGB Source Setting		0x47							
Sleep Timer	Request 0xAA	0x50	0x00: Value 0x80: Decrease by 1 0x81: Increase by 1 0xFF: Data Read	0x00	30 Sec.				
				0x01	1 Min.				
				0x02	2 Min.				
				0x03	5 Min.				
	Response 0x55			0x04	10 Min.				
				0x05	30 Min.				
				0x06	60 Min.				
Zoom Mode		0x51	0x00: Value 0x80: Decrease by 1 0x81: Increase by 1 0xFF: Data Read	0x00	Normal				
				0x01	Over Scan				
Auto Source		0x54	0x00: Value 0x80: Decrease by 1 0x81: Increase by 1 0xFF: Data Read	0x00	Off				
				0x01	On				

Image Flip		0x56	0x00: Value 0x80: Decrease by 1 0x81: Increase by 1 0xFF: Data Read	0x00	Off		
				0x01	On		
Image Mirror			0x57	QUERY(Get Current Status) 0xFF	0x00	Off	
					0x01	On	
Led Status		0x59		0xFF	*Led Status		
Flip-Flop		0xFF	0x00: Value 0x80: Decrease by 1 0x81: Increase by 1 0xFF: Data Read	0x00	*Flip-Flop		
				0x01			
				0x02			
				0x03			

* Check sum = Header Byte XOR Command XOR Byte Type Byte XOR Data Byte

* Data Type

0x00	: Value	=> * Data :	0x00 ~ 0xFF	(All)
0x80	: Decrement by 1	=> * Data :	0x00	(All)
0x81	: Increment by 1	=> * Data :	0x00	(All)
0xFF	: Data Read	=> * Data :	Request - 0x00	Response - 0x00 ~ 0xFF

* Key Code

	Remocon Key Command	
	IRKEY_POWER	= 0x00,
	IRKEY_INPUT_SOURCE	= 0x12,
	IRKEY_AUTO	= 0x03,
	IRKEY_MENU	= 0x02,
	IRKEY_UP	= 0x05,
	IRKEY_DOWN	= 0x0D,
	IRKEY_LEFT	= 0x08,
	IRKEY_RIGHT	= 0x0A,
	IRKEY_AV	= 0x0C,
	IRKEY_HDMI	= 0x07,
	IRKEY_DVI	= 0x06,
	IRKEY_PC	= 0x04,
	IRKEY_SELECT	= 0x09,

* Menu Status

0x00	Menu Off
0x01	Menu On
0x02	OSD Bar On
0x03	OSD Bar & Menu On

* Led Status

0x00	OFF
0x01	LED_RED
0x02	LED_GREEN
0x03	LED_AMBER
0x04	LED_RED_Blink
0x05	LED_GREEN_Blink
0x06	LED_AMBER_Blink
0x07	LED_RED_GREEN_TOGGLE

* Flip-Flop

0x00	FLIP OFF & FLOP OFF
0x01	FLIP ON & FLOP OFF
0x02	FLIP ON & FLOP ON
0x03	FLIP ONN & FLOP ON

13. Appendix – E (Dip Switches' Setting & supportable LCD List)

13.1 Reference Data

13.1.1 Limiting Value

Symbol	Description	Min	Max	Unit
DC In	Voltage Input	+11.4V	+12.6V	V(DC)
DC Out (LVDS VCC)	Voltage Output	+11.4V	+12.6V	V(DC)
Current Output (LVDS VCC)	Current Output			A(DC)
DC Out (Touch Power)	Voltage Output	+4.75V	+5.25V	V(DC)
Current Output(Touch Power)	Current Output			A(DC)

13.1.2 Etc. Data

Parameter	Value	Unit
Dimensions:		
Depth	100	mm
Width	140	mm
Height	20	mm
Operating Temperature	-30 ~ 80	°C
Storage Temperature	-30 ~ 80	°C

13.2 Option Jumper Setting

13.2.1 LCD Vcc Selection Jumper (JP1)

Panel Vcc	Jumper Setting
+12V	
+10V	
+5V	
+3.3V	

Dimming Type	Setting of the 8th switch	Dimming Type	Setting of the 8th switch
Analog Type		PWM Type	

13.2.2 Inverter Control Selection ; SW1

13.2.3 LVDS Type selection; SW1

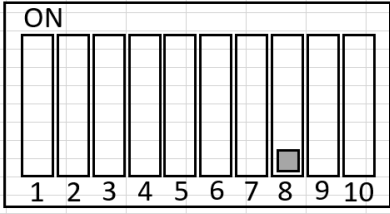
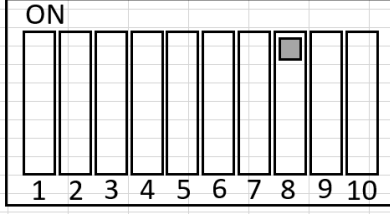
LVDS Type	Setting of the 8th switch
JEIDA (normal) format	 <p>The diagram shows a row of 10 switches labeled 1 through 10. The word "ON" is written above the switches. Switch 8 is the only one with a small grey square in its lower half, indicating it is turned ON.</p>
VESA format	 <p>The diagram shows a row of 10 switches labeled 1 through 10. The word "ON" is written above the switches. Switch 8 is the only one with a small grey square in its upper half, indicating it is turned ON.</p>

14. Appendix – F (Firmware Upgrade)

There are 2 kinds of download systems.

14.1 The download through USB port (CN11 connector at the left top on the PCB)
This is for factory use or for any System Integrator who can use this port, i.e., before any assembly work into the enclosure (housing). Factory personnel or the System Integrator can do the download via this CN11 connector (USB port). In this case you will need to attach the interconnection cable (refer to the picture).

The steps for F/W download.

1. Unplug the 12V DC jack of Venus4 board.
2. Connect the USB cable (optional) to the connector CN11.

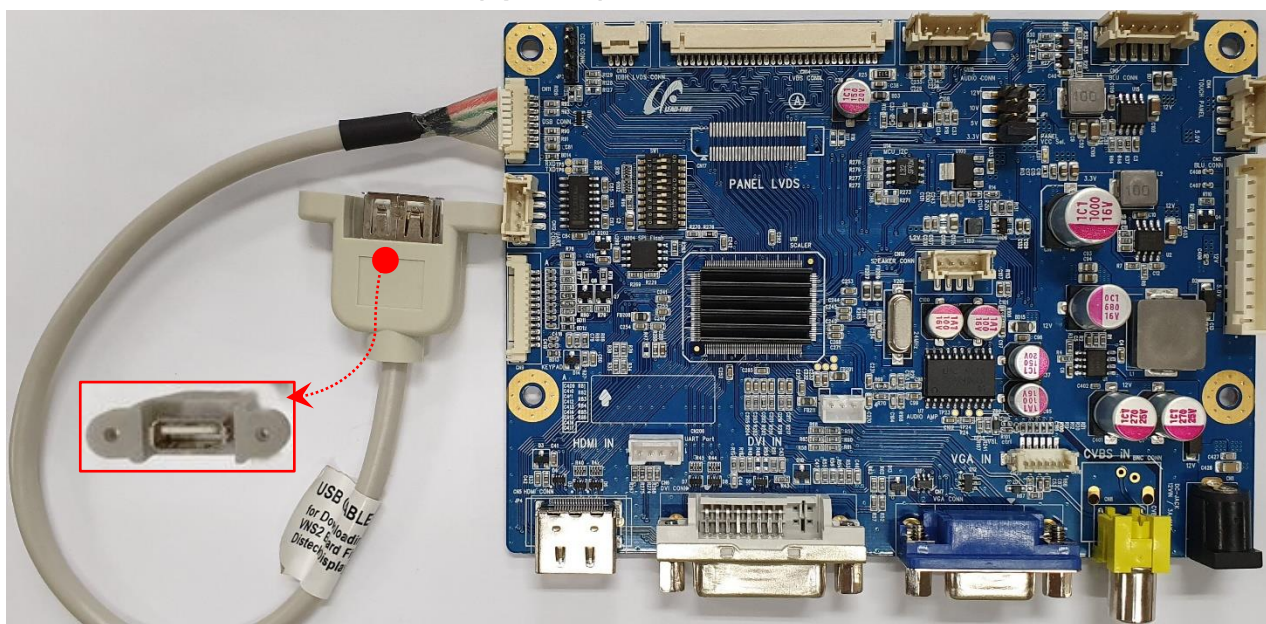

3. Save the Firmware in the root folder of any USB memory stick. The Firmware file name is 'MERGE.bin'.
4. Insert the USB memory stick into the USB cable of Venus4.
5. Hold down the "Menu" key and insert the 12V DC jack to the Venus4 board.
6. The LED on the OSD board will start to blink (cycling through Green and Red) after a few seconds.
7. Just after the LED starts to blink, release the finger which has been pressing the "Menu" button on the OSD board, then the firmware is downloaded automatically.
8. In a few seconds, the LED color will change to Amber.
9. Unplug the 12V DC jack from Venus4 board

The above procedure takes less than 30 seconds.

14.2 The download through VGA port on Venus4 board

Once the board has been assembled into a housing and shipped to the customer, if any firmware update or changing the installed firmware are requested, the user needs to carry out the download procedure via the VGA port. Please contact the supplier to obtain the download program and ISP tool with the user's manual file.

15. Appendix – G (Electrical Specification)

15.1 Electrical Specification

ITEM		DESCRIPTION			REMARKS	
		MIN	TYP	MAX		
POWER SUPPLY	12V	11.50V	12.00V	13.00V	OPTION (ADAPTOR, SMPS)	
	5.0V	4.80V	5.00V	5.20V		
	3.3V	3.20V	3.30V	3.40V		
	1.8V	1.75V	1.80V	1.85V		
	1.2V	1.15V	1.20V	1.30V		
CURRENT CONSUMPTION	DPMS	12V	-	0.1100A	-	LED OFF (with HDMI Signal)
	Normal	12V	-	0.15A	0.25A	Without Panel LED ON (with HDMI Signal)
		5.0V	-	0.01A	0.02A	
		3.3V	-	0.50A	0.60A	
		1.8V	-	0.11A	0.13A	
		1.2V	-	0.20A	0.30A	
		12V	-	1.7200A	-	With Panel (G215HVN01.0)
		5.0V	-	0.6290A	-	
		3.3V	-	0.5720A	-	
		1.8V	-	0.1200A	-	
1.2V		-	0.2600A	-		

15.2 Power Block Diagram

