

EXAMINED BY :	EMERGING DISPLAY TECHNOLOGIES CORPORATION	FILE NO . CAS-0008599
<b>Sam Chou</b>		ISSUE : FEB.26, 2021
APPROVED BY:		TOTAL PAGE : 32
<i>Chris Wu</i>		VERSION : 6

CUSTOMER ACCEPTANCE SPECIFICATIONS

MODEL NO. :

ETM070018EDHA

(GP)

FOR MESSRS :

\_\_\_\_\_

CUSTOMER'S APPROVAL

DATE :

\_\_\_\_\_

BY :

\_\_\_\_\_

RECORDS OF REVISION	DOC . FIRST ISSUE	FEB.21, 2018
---------------------	-------------------	--------------

DATE	REVISED PAGE NO.	SUMMARY																																																																																																																																																																																								
APR.26, 2018	8	ADD 5.1.2 LVDS DATA FORMAT																																																																																																																																																																																								
JUN.06, 2018	8	ADD 5.1.3 TIMING																																																																																																																																																																																								
	24	13.2.4 INSPECTION METHOD (a)APPLICABLE STANDARD : MIL-STD-105E, NORMAL INSPECTION, SINGLE SAMPLING, LEVEL II →ANSI/ ASQ Z1.4 NORMAL INSPECTION LEVEL II																																																																																																																																																																																								
MAY.26, 2020	3	3.3 ENVIRONMENTAL ABSOLUTE MAXIMUM RATINGS AMBIENT TEMPERATURE: REMARK: ADD NOTE ( 4 ) NOTE ( 1 ) : Ta AT -30°C : WILL BE 48HRS MAX. 85°C : WILL BE 48HRS MAX. →THE ABSOLUTE MAXIMUM RATINGS OF THIS PRODUCT SHOULD NOT BE EXCEEDED AT ANY TIME. IF THESE RATINGS ARE EXCEEDED, THE PRODUCT'S PERFORMANCE IS NOT GUARANTEED AND THE PRODUCT MAY EXPERIENCE PERMANENT DAMAGE.																																																																																																																																																																																								
	4	4.1 FOR LCD MODULE NOTE ( 2 ) : DELETE HSYNC, VSYNC, 12 LED CHIPS																																																																																																																																																																																								
	7	5.1.1 SWITCHING CHARACTERISTICS AND AC TIMING DIAGRAMS (LVDS) VCC/2 →VDD/2, VCC →VDD																																																																																																																																																																																								
	8	5.1.3 TIMING DELETE HV MODE																																																																																																																																																																																								
			ADD 5.1.4 DATA INPUT FORMAT																																																																																																																																																																																							
	11		6.1 OPTICAL SPECIFICATIONS <table border="1"> <thead> <tr> <th>ITEM</th> <th>SYMBOL</th> <th>CONDITION</th> <th>MIN.</th> <th>TYP.</th> <th>MAX.</th> <th>UNIT</th> <th>REMARK</th> </tr> </thead> <tbody> <tr> <td rowspan="4">VIEWING ANGLE</td> <td><math>\theta_{v+}</math></td> <td rowspan="4">CR ≥ 10</td> <td rowspan="4"><math>\theta_x=0^\circ</math></td> <td>70</td> <td>80</td> <td>—</td> <td rowspan="4">deg . NOTE ( 2 ) NOTE ( 3 )</td> </tr> <tr> <td><math>\theta_{v-}</math></td> <td>70</td> <td>80</td> <td>—</td> </tr> <tr> <td><math>\theta_{v+}</math></td> <td rowspan="2"><math>\theta_y=0^\circ</math></td> <td>70</td> <td>80</td> <td>—</td> </tr> <tr> <td><math>\theta_{v-}</math></td> <td>70</td> <td>80</td> <td>—</td> </tr> <tr> <td>CONTRAST RATIO</td> <td>CR</td> <td><math>\theta_x=0^\circ, \theta_y=0^\circ</math></td> <td>600</td> <td>800</td> <td>—</td> <td>NOTE ( 3 )</td> </tr> <tr> <td>RESPONSE TIME</td> <td><math>T_R</math> (rise) + <math>T_F</math> (fall)</td> <td><math>\theta_x=0^\circ, \theta_y=0^\circ</math></td> <td>—</td> <td>30</td> <td>45</td> <td>ms</td> <td>NOTE ( 4 )</td> </tr> <tr> <td rowspan="8">COLOR OF CIE COORDINATE</td> <td rowspan="2">WHITE</td> <td rowspan="8"><math>\theta_x=0^\circ, \theta_y=0^\circ</math> VDD-VSS=3.3V VCC-VSS=5.0V NTSC : 57%</td> <td>Wx</td> <td>0.28</td> <td>0.33</td> <td>0.38</td> <td rowspan="8">—</td> <td rowspan="8">NOTE ( 5 )</td> </tr> <tr> <td>Wy</td> <td>0.34</td> <td>0.39</td> <td>0.44</td> </tr> <tr> <td rowspan="2">RED</td> <td>Rx</td> <td>0.55</td> <td>0.60</td> <td>0.65</td> </tr> <tr> <td>Ry</td> <td>0.30</td> <td>0.35</td> <td>0.40</td> </tr> <tr> <td rowspan="2">GREEN</td> <td>Gx</td> <td>0.29</td> <td>0.34</td> <td>0.39</td> </tr> <tr> <td>Gy</td> <td>0.59</td> <td>0.64</td> <td>0.69</td> </tr> <tr> <td rowspan="2">BLUE</td> <td>Bx</td> <td>0.09</td> <td>0.14</td> <td>0.19</td> </tr> <tr> <td>By</td> <td>0.02</td> <td>0.07</td> <td>0.12</td> </tr> <tr> <td>THE BRIGHTNESS OF MODULE</td> <td>B</td> <td></td> <td>340</td> <td>425</td> <td>—</td> <td>cd/m<sup>2</sup></td> <td>NOTE ( 6 )</td> </tr> </tbody> </table> <table border="1"> <thead> <tr> <th>ITEM</th> <th>SYMBOL</th> <th>CONDITION</th> <th>MIN.</th> <th>TYP.</th> <th>MAX.</th> <th>UNIT</th> <th>REMARK</th> </tr> </thead> <tbody> <tr> <td rowspan="4">VIEWING ANGLE</td> <td><math>\theta_{v+}</math></td> <td rowspan="4">CR ≥ 10</td> <td rowspan="4"><math>\theta_x=0^\circ</math></td> <td>80</td> <td>—</td> <td>—</td> <td rowspan="4">deg . NOTE ( 2 ) NOTE ( 3 )</td> </tr> <tr> <td><math>\theta_{v-}</math></td> <td>80</td> <td>—</td> <td>—</td> </tr> <tr> <td><math>\theta_{v+}</math></td> <td rowspan="2"><math>\theta_y=0^\circ</math></td> <td>80</td> <td>—</td> <td>—</td> </tr> <tr> <td><math>\theta_{v-}</math></td> <td>80</td> <td>—</td> <td>—</td> </tr> <tr> <td>CONTRAST RATIO</td> <td>CR</td> <td><math>\theta_x=0^\circ, \theta_y=0^\circ</math></td> <td>800</td> <td>1000</td> <td>—</td> <td>NOTE ( 3 )</td> </tr> <tr> <td>RESPONSE TIME</td> <td><math>T_R</math> (rise) + <math>T_F</math> (fall)</td> <td><math>\theta_x=0^\circ, \theta_y=0^\circ</math></td> <td>—</td> <td>25</td> <td>35</td> <td>ms</td> <td>NOTE ( 4 )</td> </tr> <tr> <td rowspan="8">COLOR OF CIE COORDINATE</td> <td rowspan="2">WHITE</td> <td rowspan="8"><math>\theta_x=0^\circ, \theta_y=0^\circ</math> VDD-VSS=3.3V VCC-VSS=5.0V NTSC : 68%</td> <td>Wx</td> <td>(0.26)</td> <td>(0.31)</td> <td>(0.36)</td> <td rowspan="8">—</td> <td rowspan="8">NOTE ( 5 )</td> </tr> <tr> <td>Wy</td> <td>(0.29)</td> <td>(0.34)</td> <td>(0.39)</td> </tr> <tr> <td rowspan="2">RED</td> <td>Rx</td> <td>(0.59)</td> <td>(0.64)</td> <td>(0.69)</td> </tr> <tr> <td>Ry</td> <td>(0.30)</td> <td>(0.35)</td> <td>(0.40)</td> </tr> <tr> <td rowspan="2">GREEN</td> <td>Gx</td> <td>(0.27)</td> <td>(0.32)</td> <td>(0.37)</td> </tr> <tr> <td>Gy</td> <td>(0.58)</td> <td>(0.63)</td> <td>(0.68)</td> </tr> <tr> <td rowspan="2">BLUE</td> <td>Bx</td> <td>(0.11)</td> <td>(0.16)</td> <td>(0.21)</td> </tr> <tr> <td>By</td> <td>—</td> <td>(0.05)</td> <td>(0.10)</td> </tr> <tr> <td>THE BRIGHTNESS OF MODULE</td> <td>B</td> <td></td> <td>(340)</td> <td>(425)</td> <td>—</td> <td>cd/m<sup>2</sup></td> <td>NOTE ( 6 )</td> </tr> </tbody> </table>	ITEM	SYMBOL	CONDITION	MIN.	TYP.	MAX.	UNIT	REMARK	VIEWING ANGLE	$\theta_{v+}$	CR ≥ 10	$\theta_x=0^\circ$	70	80	—	deg . NOTE ( 2 ) NOTE ( 3 )	$\theta_{v-}$	70	80	—	$\theta_{v+}$	$\theta_y=0^\circ$	70	80	—	$\theta_{v-}$	70	80	—	CONTRAST RATIO	CR	$\theta_x=0^\circ, \theta_y=0^\circ$	600	800	—	NOTE ( 3 )	RESPONSE TIME	$T_R$ (rise) + $T_F$ (fall)	$\theta_x=0^\circ, \theta_y=0^\circ$	—	30	45	ms	NOTE ( 4 )	COLOR OF CIE COORDINATE	WHITE	$\theta_x=0^\circ, \theta_y=0^\circ$ VDD-VSS=3.3V VCC-VSS=5.0V NTSC : 57%	Wx	0.28	0.33	0.38	—	NOTE ( 5 )	Wy	0.34	0.39	0.44	RED	Rx	0.55	0.60	0.65	Ry	0.30	0.35	0.40	GREEN	Gx	0.29	0.34	0.39	Gy	0.59	0.64	0.69	BLUE	Bx	0.09	0.14	0.19	By	0.02	0.07	0.12	THE BRIGHTNESS OF MODULE	B		340	425	—	cd/m <sup>2</sup>	NOTE ( 6 )	ITEM	SYMBOL	CONDITION	MIN.	TYP.	MAX.	UNIT	REMARK	VIEWING ANGLE	$\theta_{v+}$	CR ≥ 10	$\theta_x=0^\circ$	80	—	—	deg . NOTE ( 2 ) NOTE ( 3 )	$\theta_{v-}$	80	—	—	$\theta_{v+}$	$\theta_y=0^\circ$	80	—	—	$\theta_{v-}$	80	—	—	CONTRAST RATIO	CR	$\theta_x=0^\circ, \theta_y=0^\circ$	800	1000	—	NOTE ( 3 )	RESPONSE TIME	$T_R$ (rise) + $T_F$ (fall)	$\theta_x=0^\circ, \theta_y=0^\circ$	—	25	35	ms	NOTE ( 4 )	COLOR OF CIE COORDINATE	WHITE	$\theta_x=0^\circ, \theta_y=0^\circ$ VDD-VSS=3.3V VCC-VSS=5.0V NTSC : 68%	Wx	(0.26)	(0.31)	(0.36)	—	NOTE ( 5 )	Wy	(0.29)	(0.34)	(0.39)	RED	Rx	(0.59)	(0.64)	(0.69)	Ry	(0.30)	(0.35)	(0.40)	GREEN	Gx	(0.27)	(0.32)	(0.37)	Gy	(0.58)	(0.63)	(0.68)	BLUE	Bx	(0.11)	(0.16)	(0.21)	By	—	(0.05)	(0.10)	THE BRIGHTNESS OF MODULE	B		(340)	(425)	—	cd/m <sup>2</sup>
ITEM	SYMBOL	CONDITION	MIN.	TYP.	MAX.	UNIT	REMARK																																																																																																																																																																																			
VIEWING ANGLE	$\theta_{v+}$	CR ≥ 10	$\theta_x=0^\circ$	70	80	—	deg . NOTE ( 2 ) NOTE ( 3 )																																																																																																																																																																																			
	$\theta_{v-}$			70	80	—																																																																																																																																																																																				
	$\theta_{v+}$			$\theta_y=0^\circ$	70	80		—																																																																																																																																																																																		
	$\theta_{v-}$				70	80		—																																																																																																																																																																																		
CONTRAST RATIO	CR	$\theta_x=0^\circ, \theta_y=0^\circ$	600	800	—	NOTE ( 3 )																																																																																																																																																																																				
RESPONSE TIME	$T_R$ (rise) + $T_F$ (fall)	$\theta_x=0^\circ, \theta_y=0^\circ$	—	30	45	ms	NOTE ( 4 )																																																																																																																																																																																			
COLOR OF CIE COORDINATE	WHITE	$\theta_x=0^\circ, \theta_y=0^\circ$ VDD-VSS=3.3V VCC-VSS=5.0V NTSC : 57%	Wx	0.28	0.33	0.38	—	NOTE ( 5 )																																																																																																																																																																																		
			Wy	0.34	0.39	0.44																																																																																																																																																																																				
	RED		Rx	0.55	0.60	0.65																																																																																																																																																																																				
			Ry	0.30	0.35	0.40																																																																																																																																																																																				
	GREEN		Gx	0.29	0.34	0.39																																																																																																																																																																																				
			Gy	0.59	0.64	0.69																																																																																																																																																																																				
	BLUE		Bx	0.09	0.14	0.19																																																																																																																																																																																				
			By	0.02	0.07	0.12																																																																																																																																																																																				
THE BRIGHTNESS OF MODULE	B		340	425	—	cd/m <sup>2</sup>	NOTE ( 6 )																																																																																																																																																																																			
ITEM	SYMBOL	CONDITION	MIN.	TYP.	MAX.	UNIT	REMARK																																																																																																																																																																																			
VIEWING ANGLE	$\theta_{v+}$	CR ≥ 10	$\theta_x=0^\circ$	80	—	—	deg . NOTE ( 2 ) NOTE ( 3 )																																																																																																																																																																																			
	$\theta_{v-}$			80	—	—																																																																																																																																																																																				
	$\theta_{v+}$			$\theta_y=0^\circ$	80	—		—																																																																																																																																																																																		
	$\theta_{v-}$				80	—		—																																																																																																																																																																																		
CONTRAST RATIO	CR	$\theta_x=0^\circ, \theta_y=0^\circ$	800	1000	—	NOTE ( 3 )																																																																																																																																																																																				
RESPONSE TIME	$T_R$ (rise) + $T_F$ (fall)	$\theta_x=0^\circ, \theta_y=0^\circ$	—	25	35	ms	NOTE ( 4 )																																																																																																																																																																																			
COLOR OF CIE COORDINATE	WHITE	$\theta_x=0^\circ, \theta_y=0^\circ$ VDD-VSS=3.3V VCC-VSS=5.0V NTSC : 68%	Wx	(0.26)	(0.31)	(0.36)	—	NOTE ( 5 )																																																																																																																																																																																		
			Wy	(0.29)	(0.34)	(0.39)																																																																																																																																																																																				
	RED		Rx	(0.59)	(0.64)	(0.69)																																																																																																																																																																																				
			Ry	(0.30)	(0.35)	(0.40)																																																																																																																																																																																				
	GREEN		Gx	(0.27)	(0.32)	(0.37)																																																																																																																																																																																				
			Gy	(0.58)	(0.63)	(0.68)																																																																																																																																																																																				
	BLUE		Bx	(0.11)	(0.16)	(0.21)																																																																																																																																																																																				
			By	—	(0.05)	(0.10)																																																																																																																																																																																				
THE BRIGHTNESS OF MODULE	B		(340)	(425)	—	cd/m <sup>2</sup>	NOTE ( 6 )																																																																																																																																																																																			
	13	7. OUTLINE DIMENSIONS MARK $\Delta$ : MODIFY TFT FPC STIFFENER OUTLINE																																																																																																																																																																																								
JAN.15, 2021	1	2.1 TFT MODULE MECHANICAL SPECIFICATIONS (8) LCD TYPE: ADD IPS (9) COLOR: 16.7M(8bit)→16.7M (12) INTERFACE MODE: LVDS→LVDS(8bit)																																																																																																																																																																																								

DOC . FIRST ISSUE

RECORDS OF REVISION

FEB.21, 2018

DATE

REVISED  
PAGE  
NO.

SUMMARY

JAN.15, 2021

4

4.1 FOR LCD MODULE  
POWER SUPPLY VOLTAGE: MIN.=3.0→3.1  
NOTE ( 3 ) :

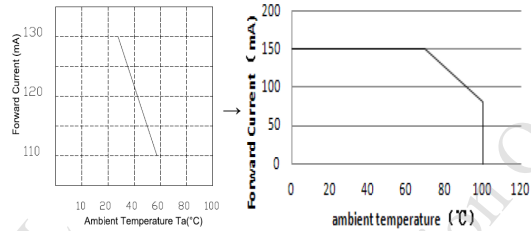

11

6.1 OPTICAL SPECIFICATIONS

ITEM	SYMBOL	CONDITION	MIN.	TYP.	MAX.	UNIT	REMARK
COLOR OF CIE COORDINATE	WHITE	Wx	(0.26)	(0.31)	(0.36)	—	NOTE ( 5 )
		Wy	(0.29)	(0.34)	(0.39)		
	RED	Rx	(0.59)	(0.64)	(0.69)		
		Ry	(0.30)	(0.35)	(0.40)		
	GREEN	Gx	(0.27)	(0.32)	(0.37)		
		Gy	(0.58)	(0.63)	(0.68)		
BLUE	Bx	(0.11)	(0.16)	(0.21)			
	By	—	(0.05)	(0.10)			
THE BRIGHTNESS OF MODULE	B		(340)	(425)	—	cd/m <sup>2</sup>	NOTE ( 6 )

↓

ITEM	SYMBOL	CONDITION	MIN.	TYP.	MAX.	UNIT	REMARK
COLOR OF CIE COORDINATE	WHITE	Wx	0.26	0.31	0.36	—	NOTE ( 5 )
		Wy	0.30	0.35	0.40		
	RED	Rx	0.59	0.64	0.69		
		Ry	0.30	0.35	0.40		
	GREEN	Gx	0.27	0.32	0.37		
		Gy	0.58	0.63	0.68		
BLUE	Bx	0.09	0.14	0.19			
	By	—	0.05	0.10			
THE BRIGHTNESS OF MODULE	B		340	425	—	cd/m <sup>2</sup>	NOTE ( 6 )

19

11.1 POWER SUPPLY FOR LCM

NOTE ( 2 ) : PWM SIGNAL=0~3.3V , OPERATION FREQUENCY :  
20±5KHz→OPERATION FREQUENCY : 15±5KHz

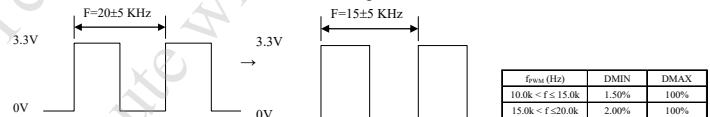

FEB.26, 2021

12

6.3 THE CALCULATING METHOD OF UNIFORMITY

$$\text{UNIFORMITY} : \left[ 1 - \frac{\text{MAXIMUM BRIGHTNESS} - \text{MINIMUM BRIGHTNESS}}{\text{AVERAGE BRIGHTNESS}} \right] \times 100\% \rightarrow$$

$$\text{UNIFORMITY} : \frac{\text{MINIMUM BRIGHTNESS}}{\text{MAXIMUM BRIGHTNESS}} * 100\%$$

TABLE OF CONTENTS

NO.	ITEM	PAGE
1.	GENERAL SPECIFICATIONS -----	1
2.	MECHANICAL SPECIFICATIONS -----	1, 2
3.	ABSOLUTE MAXIMUM RATINGS -----	3
4.	ELECTRICAL CHARACTERISTICS -----	4, 5
5.	TIMING CHARACTERISTICS -----	6 ~ 10
6.	OPTICAL CHARACTERISTICS -----	11, 12
7.	OUTLINE DIMENSIONS -----	13
8.	BLOCK DIAGRAM -----	14, 15
9.	DETAIL DRAWING OF DOT MATRIX -----	16
10.	INTERFACE SIGNALS -----	17, 18
11.	POWER SUPPLY -----	19
12.	CAPACITIVE TOUCH PANEL SPECIFICATION -----	20 ~ 23
13.	INSPECTION CRITERION -----	24 ~ 29
14.	RELIABILITY TEST -----	30
15.	CAUTION -----	31, 32

CONFIDENTIAL  
Authorized for  
Emerging Display Technologies Corporation Only.  
Do not distribute without authorization.

## 1. GENERAL SPECIFICATIONS

### 1.1 APPLICATION NOTES FOR CAPACITIVE TOUCH PANEL CONTROLLER/DRIVER PLEASE REFER TO :

HYCON HY4614

### 1.2 MATERIAL SAFETY DESCRIPTION

ASSEMBLIES SHALL COMPLY WITH EDT GREEN PRODUCT (GP) REQUIREMENTS, INCLUDING PROHIBITED MATERIALS/COMPONENTS CONTAINING LEAD, MERCURY, CADMIUM, HEXAVALENT CHROMIUM, POLYBROMINATED BIPHENYLS (PBB), POLYBROMINATED DIPHENYL ETHERS (PBDE), POLYCHLORINATED BIPHENYLS (PCB) CATEGORY, POLYCHLORINATED NAPHTHALENE (PCN) CATEGORY, POLYCHLORINATED TERPHENYLS (PCT) CATEGORY, CHLORINATED PARAFFINS (CP) CATEGORY, TRIBUTHYL TIN CATEGORY / TRIPHENYL TIN CATEGORY, ASBESTOS, SPECIFIC AZO COMPOUNDS, FORMALDEHYDE, POLYVINYL CHLORIDE (PVC) AND PVC BLENDS, OTHER BROMINATED ORGANIC COMPOUNDS AND OTHER CHLORINATED ORGANIC COMPOUNDS.

## 2. MECHANICAL SPECIFICATIONS

### 2.1 TFT MODULE MECHANICAL SPECIFICATIONS

(1) DISPLAY SIZE	-----	7 inch
(2) NUMBER OF DOTS	-----	800W * (RGB) * 480H DOTS
(3) MODULE SIZE	-----	165W * 104.44H * 11.6D(MAX.) mm (NOT INCLUDED FPC)
(4) VIEWING AREA	-----	153.8W * 92.84H mm
(5) ACTIVE AREA	-----	152.4W * 91.44H mm
(6) DOT SIZE	-----	0.0635W * 0.1905H mm
(7) PIXEL SIZE	-----	0.1905W * 0.1905H mm
(8) LCD TYPE	-----	TFT, IPS, TRANSMISSIVE, NORMALLY BLACK
(9) COLOR	-----	16.7M
(10) VIEWING DIRECTION	-----	SUPER WIDE VIEW
(11) BACK LIGHT	-----	LED , COLOR : WHITE
(12) INTERFACE MODE	-----	LVDS(8bit)

MODEL NO.	VERSION	PAGE
ETM070018EDHA	6	2

## 2.2 CAPACITIVE TOUCH PANEL MECHANICAL SPECIFICATIONS

- (1) TOUCH PANEL SIZE ----- 7.0 inch
- (2) OUTER DIMENSION ----- 164W \* 104H \* 1.4D mm  
(NOT INCLUDED FPC)
- (3) ACTIVE AREA ----- 154W \* 93.05H mm
- (4) INPUT TYPE ----- MULTI TOUCH
- (5) NUMBER OF TOUCH SENSOR ----- 28\*16 SENSORS
- (6) RESOLUTION ----- 1792\*1024
- (7) INTERFACE MODE ----- I2C

CONFIDENTIAL  
Authorized for  
Emerging Display Technologies Corporation Only.  
Do not distribute without authorization.

### 3. ABSOLUTE MAXIMUM RATINGS

#### 3.1 FOR LCD MODULE

ITEM	SYMBOL	MIN.	MAX.	UNIT	REMARK
POWER SUPPLY VOLTAGE	VDD-VSS	3	3.6	V	
	VCC-VSS	2.5	5.5	V	
LVDS DRIVER OUTPUT VOLTAGE	—	-0.3	VDD+0.3	V	
STATIC ELECTRICITY	—	—	—	V	NOTE ( 1 )

NOTE ( 1 ) : LCM SHOULD BE GROUNDED DURING HANDLING LCM.

#### 3.2 FOR CTP MODULE

PARAMETER	SYMBOL	MIN.	MAX.	UNIT	REMARK
POWER SUPPLY FOR DRIVER	VDD1-VSS1	-0.2	4.0	V	
INPUT VOLTAGE	VIN	-0.2	4.0	V	

#### 3.3 ENVIRONMENTAL ABSOLUTE MAXIMUM RATINGS

ITEM	OPERATING		STORAGE		REMARK
	MIN.	MAX.	MIN.	MAX.	
AMBIENT TEMPERATURE	-30°C	85°C	-30°C	85°C	NOTE ( 1 ), ( 2 ), ( 3 ), ( 4 )
HUMIDITY	NOTE ( 4 )		NOTE ( 4 )		WITHOUT CONDENSATION
VIBRATION	—	2.45 m/s <sup>2</sup> (0.25G)	—	11.76m/s <sup>2</sup> (1.2G)	10~100 Hz XYZ DIRECTIONS 1 HR EACH
SHOCK	—	29.4 m/s <sup>2</sup> (3G)	—	490.0 m/s <sup>2</sup> (50G)	10 ms XYZ DIRECTIONS 1 TIME EACH
CORROSIVE GAS	NOT ACCEPTABLE		NOT ACCEPTABLE		

NOTE ( 1 ) : THE ABSOLUTE MAXIMUM RATINGS OF THIS PRODUCT SHOULD NOT BE EXCEEDED AT ANY TIME. IF THESE RATINGS ARE EXCEEDED, THE PRODUCT'S PERFORMANCE IS NOT GUARANTEED AND THE PRODUCT MAY EXPERIENCE PERMANENT DAMAGE.

NOTE ( 2 ) : BACKGROUND COLOR CHANGES SLIGHTLY DEPENDING ON AMBIENT TEMPERATURE THIS PHENOMENON IS REVERSIBLE.

NOTE ( 3 ) : WHEN THE LCD MODULE IS OPERATED AT A HIGHER AMBIENT TEMPERATURE THAN 60°C, THE PWM DUTY CYCLE OF THE LED BACKLIGHT SHOULD BE ADJUSTED TO BE LESS THAN 70%. IF THE MODULE IS OPERATED AT A HIGHER DUTY CYCLE THAN 70%, THEN THERE IS A POSSIBILITY OF DISTORTION AND IRREGULARITY OF THE PICTURE DUE TO LIQUID CRYSTAL BEHAVIOR.

NOTE ( 4 ) : Ta ≤ 40°C : 90%RH MAX. (96HRS MAX).

Ta > 40°C : ABSOLUTE HUMIDITY MUST BE LOWER THAN THE HUMIDITY OF 90%RH AT 40°C (96HRS MAX).

#### 4. ELECTRICAL CHARACTERISTICS

##### 4.1 FOR LCD MODULE

ITEM	SYMBOL	CONDITION	MIN.	TYP.	MAX.	UNIT	REMARK
POWER SUPPLY VOLTAGE	VDD-VSS	—	3.1	3.3	3.6	V	
POWER SUPPLY VOLTAGE FOR LED DRIVER	VCC-VSS	—	4.7	5.0	5.3	V	
POWER SUPPLY CURRENT	IDD	VDD-VSS=3.3V	—	220	270	mA	NOTE ( 1 )
POWER SUPPLY CURRENT FOR LED DRIVER	ICC	VCC-VSS=5.0V	—	485	630	mA	
LVDS DIFFERENTIAL INPUT HIGH THRESHOLD	VTH	VOC=+1.2V	—	—	100	mV	
LVDS DIFFERENTIAL INPUT LOW THRESHOLD	VTL		-100	—	—	mV	
LOW LEVEL INPUT VOLTAGE	VIL	—	VSS	—	0.3*VDD	V	NOTE ( 2 )
HIGH LEVEL INPUT VOLTAGE	VIH	—	0.7*VDD	—	VDD	V	
LVDS CLK FREQUENCY	—	VDD-VSS=3.3V	20	—	85	MHz	
FRAME FREQUENCY	fFRAME	—	50	60	72	Hz	
LED LIFE TIME	—	I <sub>LED</sub> =55mA (PER LED)	50K	—	—	hrs	NOTE ( 4 ) NOTE ( 5 )

NOTE ( 1 ) : THE DISPLAY PATTERN IS ALL "WHITE".

NOTE ( 2 ) : APPLIED TO TERMINALS U/D , L/R , R0~R5 , G0~G5 , B0~B5 , ENB , DCLK.

NOTE ( 3 ) : AMBIENT TEMP. VS. ALLOWABLE FORWARD CURRENT.(PER LED)

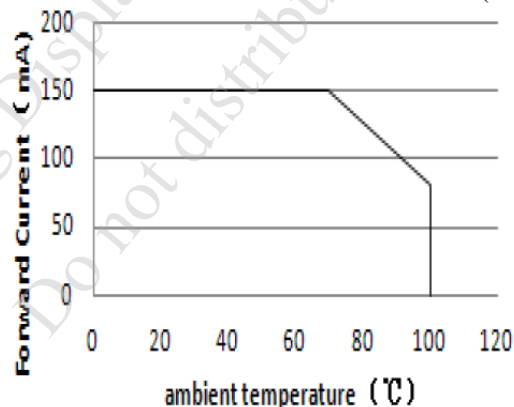

NOTE ( 4 ) : CONDITIONS; TA=25 °C, CONTINUOUS LIGHTING.

NOTE ( 5 ) : DEFINITIONS OF LIFE TIME

LCD LUMINANCE BECOMES HALF OF THE INITIAL VALUE.

4.2 FOR CTP MODULE

Ta=25°C

ITEM	SYMBOL	CONDITION	MIN.	TYP.	MAX.	UNIT
POWER SUPPLY FOR DRIVER	VDD1-VSS1	—	2.8	3.3	3.6	V
INPUT HIGH LEVEL VOLTAGE	VIH	—	—	0.7*VDD	—	V
INPUT LOW LEVEL VOLTAGE	VIL	—	—	0.3*VDD	—	V
OUTPUT HIGH LEVEL VOLTAGE	VOH	IOH=10mA	VDD-0.3	—	—	V
OUTPUT LOW LEVEL VOLTAGE	VOL	IOH=-10mA	—	—	VSS+0.3	V
POWER SUPPLY CURRENT CONSUMPTION FOR OPERATION	IDD1	VDD1-VSS1 =3.3V	—	10	15	mA

CONFIDENTIAL  
Authorized for  
Emerging Display Technologies Corporation Only.  
Do not distribute without authorization.

5. TIMING CHARACTERISTICS

5.1 FOR LCD MODULE

5.1.1 SWITCHING CHARACTERISTICS AND AC TIMING DIAGRAMS (LVDS)

ITEM	SYMBOL	MIN.	TYP.	MAX.	UNIT
CLK OUT PERIOD	$t_{RCP}$	11.76	T	50.0	ns
CLK OUT HIGH TIME	$t_{RCH}$	—	4T/7	—	ns
CLK OUT LOW TIME	$t_{RCL}$	—	3T/7	—	ns
RCLK +/- TO CLK OUT DELAY	$t_{RCD}$	—	5T/7	—	ns
TTL DATA SETUP TO CLK OUT	$t_{RS}$	0.35T-0.3	—	—	ns
TTL DATA HOLD FROM CLK OUT	$t_{RH}$	0.45T-1.6	—	—	ns
TTL LOW TO HIGH TRANSITION TIME	$t_{TLH}$	—	2.0	3.0	ns
TTL HIGH TO LOW TRANSITION TIME	$t_{THL}$	—	1.8	3.0	ns
INPUT DATA POSITION0 (T=11.76ns)	$t_{RIP1}$	-0.4	0.0	0.4	ns
INPUT DATA POSITION1 (T=11.76ns)	$t_{RIP0}$	T/7-0.4	T/7	T/7+0.4	ns
INPUT DATA POSITION2 (T=11.76ns)	$t_{RIP6}$	2T/7-0.4	2T/7	2T/7+0.4	ns
INPUT DATA POSITION3 (T=11.76ns)	$t_{RIP5}$	3T/7-0.4	3T/7	3T/7+0.4	ns
INPUT DATA POSITION4 (T=11.76ns)	$t_{RIP4}$	4T/7-0.4	4T/7	4T/7+0.4	ns
INPUT DATA POSITION5 (T=11.76ns)	$t_{RIP3}$	5T/7-0.4	5T/7	5T/7+0.4	ns
INPUT DATA POSITION6 (T=11.76ns)	$t_{RIP2}$	6T/7-0.4	6T/7	6T/7+0.4	ns
PHASE LOCK LOOP SET	$t_{RPLL}$	—	—	10.0	ms

TTL OUTPUT

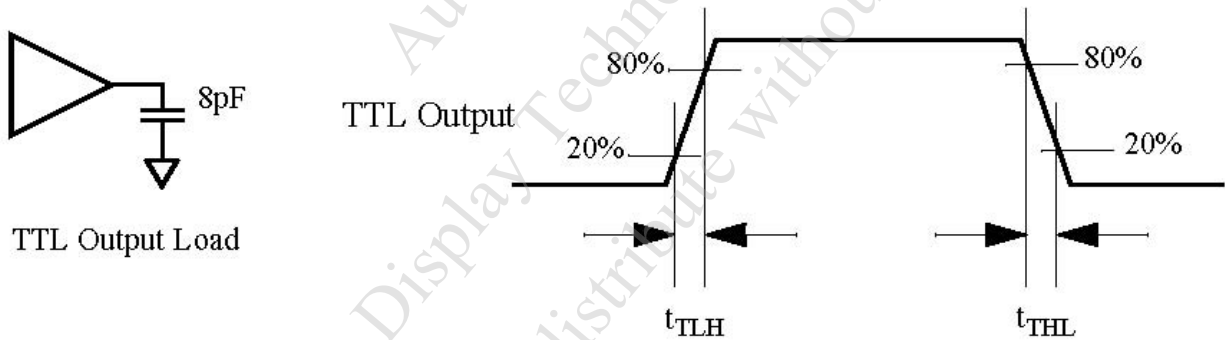

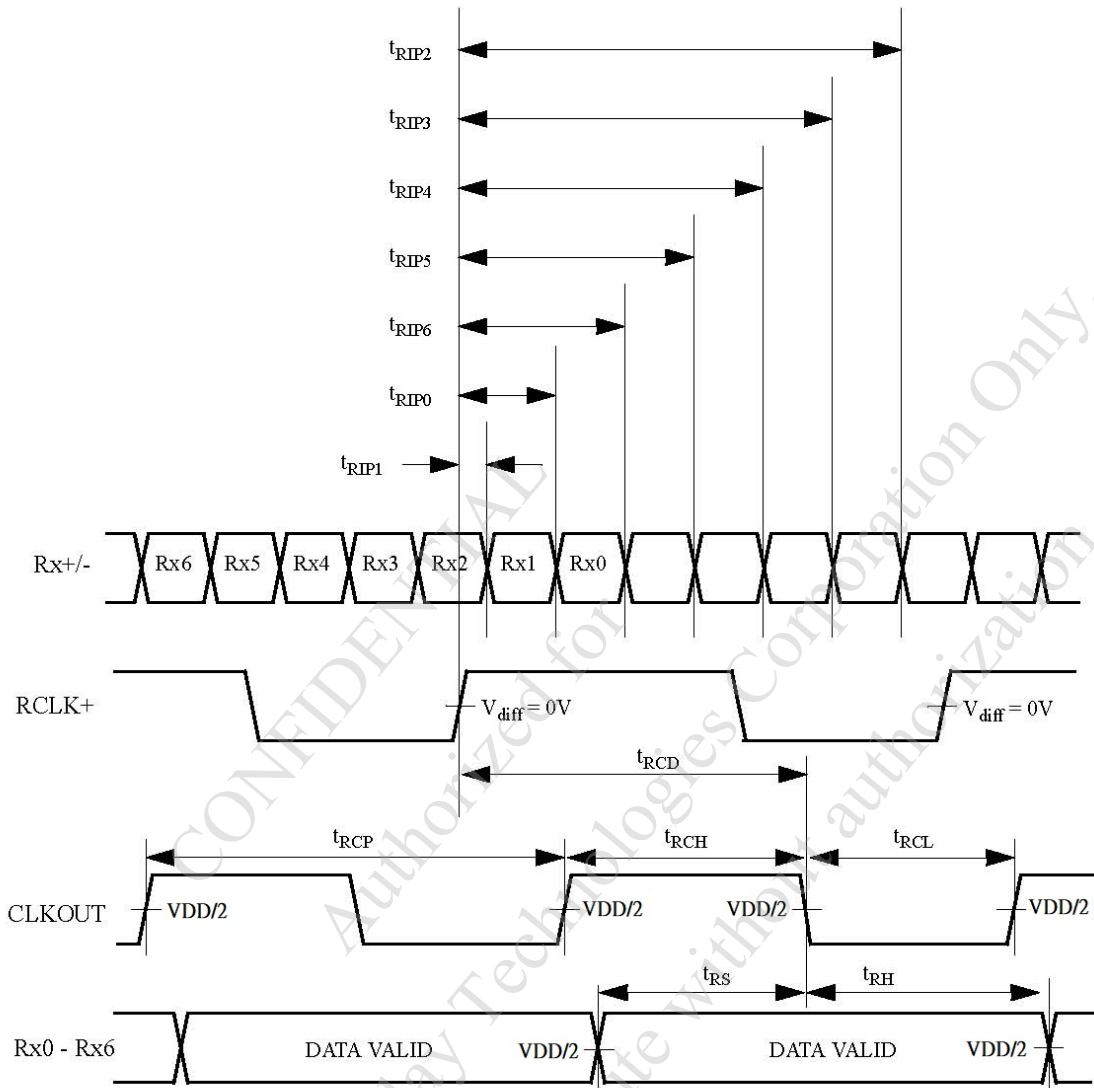

Note:

1)  $V_{diff} = (RA+) - (RA-), \dots, (RCLK+) - (RCLK-)$

### PHASE LOCK LOOP SET TIME

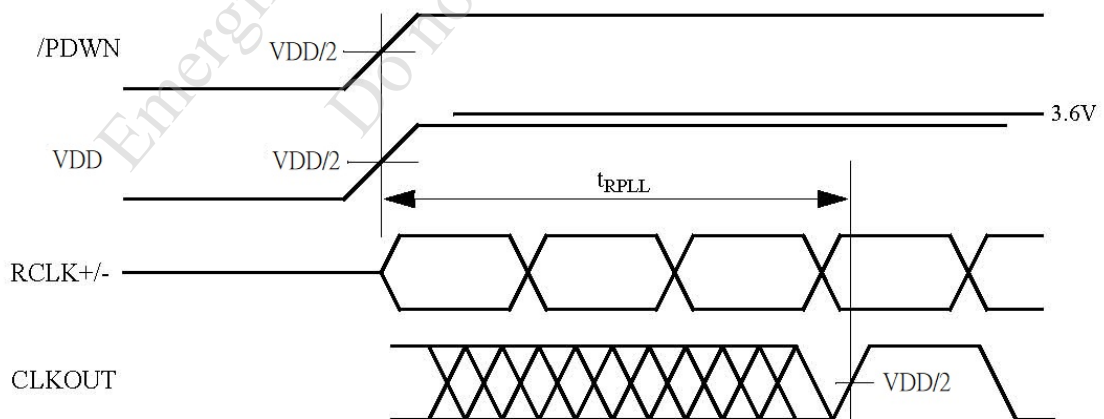

### 5.1.2 LVDS DATA FORMAT

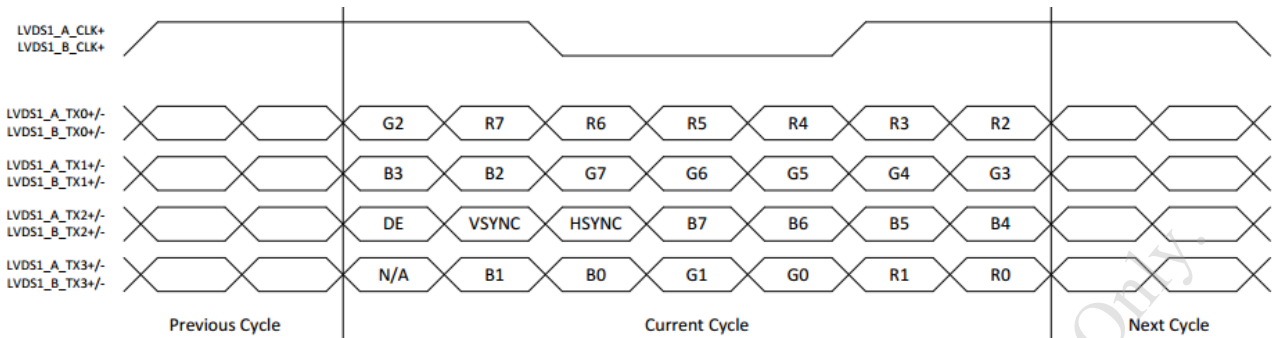

### 5.1.3 TIMING

#### DE MODE

PARAMETER	SYMBOL	MIN.	TYP.	MAX.	UNIT	REMARK
CLK FREQUENCY	$F_{CLK}$	25.2	25.4	35.7	MHz	FRAME RATE =60Hz
HORIZONTAL DISPLAY AREA	$T_{HD}$	800			CLK	
HS PERIOD TIME	$T_H$	860	864	974	CLK	
HS BLANKING	$T_{HFP} + T_{HBP}$	60	64	174	CLK	
VERTICAL DISPLAY AREA	$T_{VD}$	480			H	
VS PERIOD TIME	$T_V$	488	490	611	H	
VS BLANKING	$T_{VBP} + T_{VFP}$	8	10	131	H	

### 5.1.4 DATA INPUT FORMAT

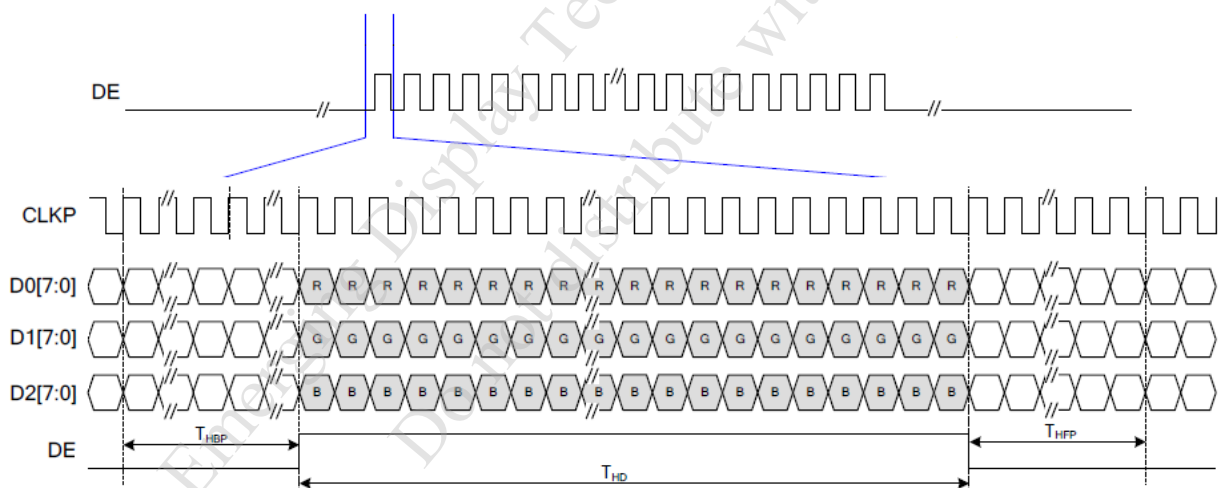

5.2 FOR CTP MODULE

5.2.1 I2C INTERFACE TIMING CHARACTERISTICS

ITEM	MIN.	TYP.	MAX.	UNIT
SCL FREQUENCY	0	—	400	KHz
BUS FREE TIME BETWEEN A STOP AND START CONDITION	1.3	—	—	us
HOLD TIME (REPEATED) START CONDITION	0.6	—	—	us
DATA SETUP TIME	100	—	—	ns
SETUP TIME FOR A REPEATED START CONDITION	0.6	—	—	us
SETUP TIME FOR STOP CONDITION	0.6	—	—	us

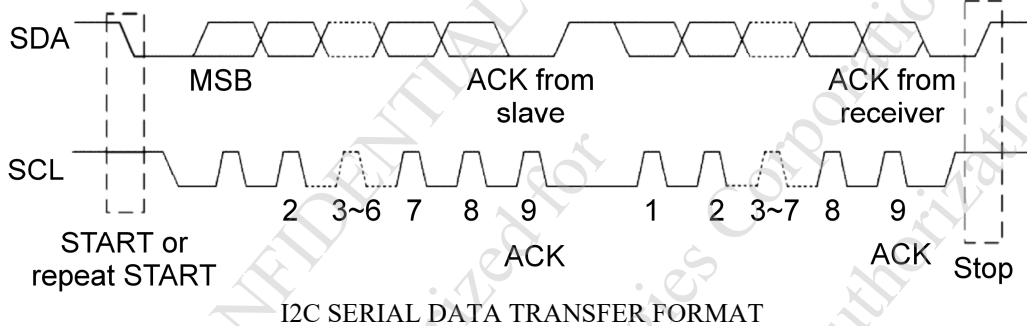

CONFIDENTIAL  
 Authorized for  
 Emerging Display Technologies Corporation Only  
 Do not distribute without authorization.

5.2.2 POWER SEQUENCE

ITEM	SYMBOL	MIN.	TYP.	MAX.	UNIT
RISE TIME FROM 0.1VDD TO 0.9VDD	Tris	—	—	5	ms
TIME OF RESETTING TO BE LOW BEFORE POWERING ON	Trtp	100	—	—	us
TIME OF STARTING TO REPORT POINT AFTER POWERING ON	Tpon	200	—	—	ms
RESET TIME AFTER VDD POWERING ON	Tvdr	1	—	—	ms
TIME OF STARTING TO REPORT POINT AFTER RESETTING	Trsi	200	—	—	ms
RESET TIME	Trst	2	—	—	ms

POWER RISE TIMING

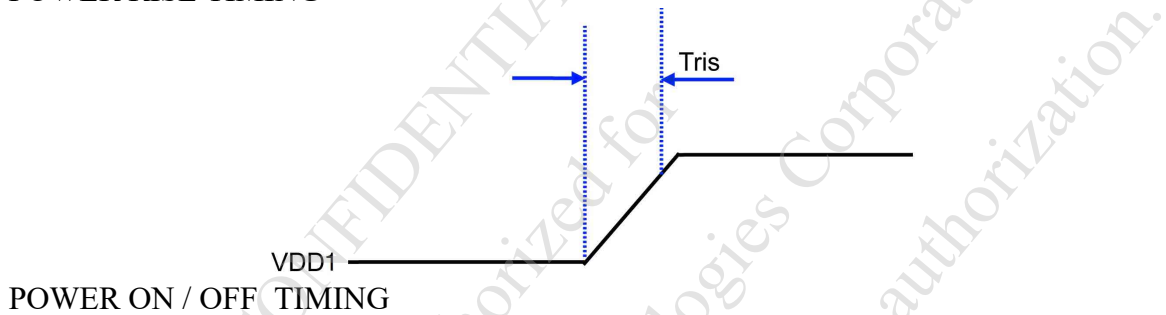

POWER ON / OFF TIMING

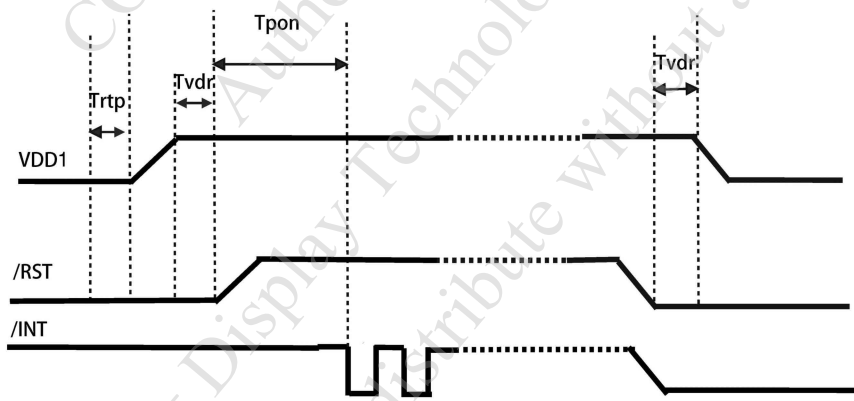

RESET SEQUENCE

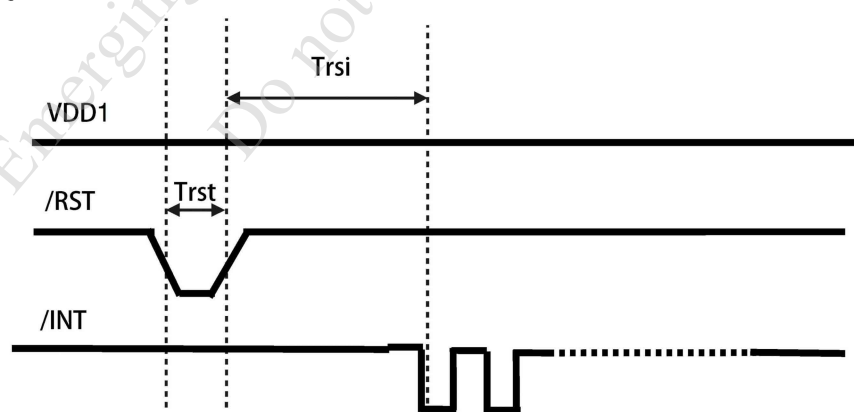

6. OPTICAL CHARACTERISTICS

6.1 OPTICAL SPECIFICATIONS

Ta = 25 ± 2 °C

ITEM	SYMBOL	CONDITION	MIN.	TYP.	MAX.	UNIT	REMARK	
VIEWING ANGLE	$\theta_{y+}$	CR ≥ 10	80	—	—	deg.	NOTE (2) NOTE (3)	
	$\theta_{y-}$		$\theta_x=0^\circ$	80	—			—
	$\theta_{x+}$		$\theta_y=0^\circ$	80	—			—
	$\theta_{x-}$			80	—			—
CONTRAST RATIO	CR	$\theta_x=0^\circ, \theta_y=0^\circ$	800	1000	—	—	NOTE (3)	
RESPONSE TIME	T <sub>R</sub> (rise) + T <sub>F</sub> (fall)	$\theta_x=0^\circ, \theta_y=0^\circ$	—	25	35	ms	NOTE (4)	
COLOR OF CIE COORDINATE	WHITE	W <sub>x</sub>	$\theta_x=0^\circ, \theta_y=0^\circ$ VDD-VSS=3.3V VCC-VSS=5.0V NTSC : 68%	0.26	0.31	0.36	—	NOTE (5)
		W <sub>y</sub>		0.30	0.35	0.40		
	RED	R <sub>x</sub>		0.59	0.64	0.69	—	
		R <sub>y</sub>		0.30	0.35	0.40		
	GREEN	G <sub>x</sub>		0.27	0.32	0.37	—	
		G <sub>y</sub>		0.58	0.63	0.68		
	BLUE	B <sub>x</sub>		0.09	0.14	0.19	—	
		B <sub>y</sub>		—	0.05	0.10		
THE BRIGHTNESS OF MODULE	B		340	425	—	cd/m <sup>2</sup>	NOTE (6)	
THE UNIFORMITY OF MODULE	—		70	—	—	%		

NOTE (1) : TEST EQUIPMENT SETUP :

AFTER STABILIZING AND LEAVING THE PANEL ALONE AT A GIVEN TEMPERATURE FOR 30 MINUTES, MEASUREMENT SHOULD BE EXECUTED IN A STABLE, WINDLESS, AND DARK ROOM. OPTICAL SPECIFICATIONS ARE MEASURED BY TOPCON BM-7 (FAST) WITH A VIEWING ANGLE OF 1° AT A DISTANCE OF 50cm AND NORMAL DIRECTION.

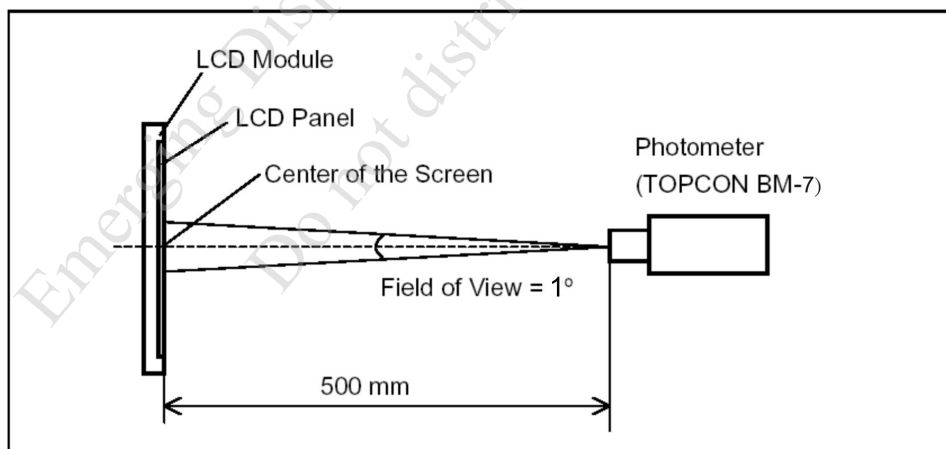

NOTE ( 2 ) : DEFINITION OF VIEWING ANGLE :

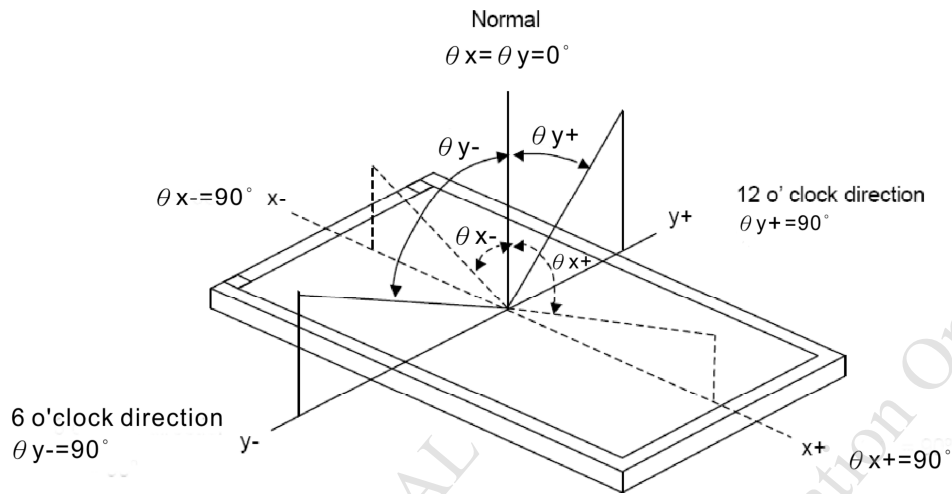

NOTE ( 3 ) : DEFINITION OF CONTRAST RATIO :

$$\text{CONTRAST RATIO(CR)} = \frac{\text{BRIGHTNESS MEASURED WHEN LCD IS AT "WHITE STATE"}}{\text{BRIGHTNESS MEASURED WHEN LCD IS AT "BLACK STATE"}}$$

NOTE ( 4 ) : DEFINITION OF RESPONSE TIME : TR AND TF

THE FIGURE BELOW IS THE OUTPUT SIGNAL OF THE PHOTO DETECTOR.

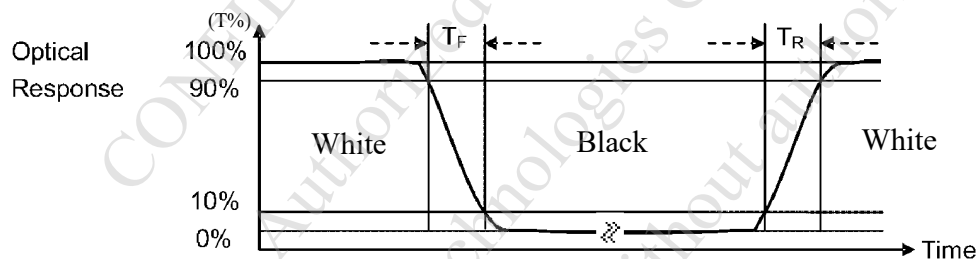

NOTE ( 5 ) : THE 100% TRANSMISSION IS DEFINED AS THE TRANSMISSION OF LCD PANEL WHEN ALL THE INPUT TERMINALS OF MODULE ARE ELECTRICALLY OPENED.

NOTE ( 6 ) : BRIGHTNESS MEASURED WHEN LCD IS AT "WHITE STATE".

## 6.2 THE TEST METHOD OF BRIGHTNESS AND UNIFORMITY

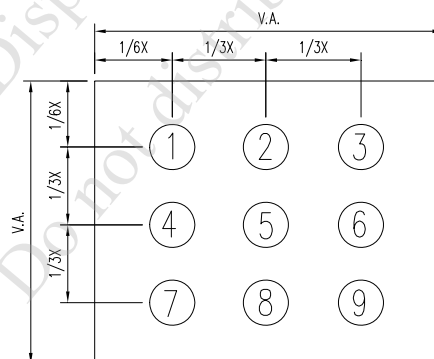

UNIT : mm

## 6.3 THE CALCULATING METHOD OF UNIFORMITY

$$\text{UNIFORMITY} : \frac{\text{MINIMUM BRIGHTNESS}}{\text{MAXIMUM BRIGHTNESS}} * 100\%$$

7. OUTLINE DIMENSIONS

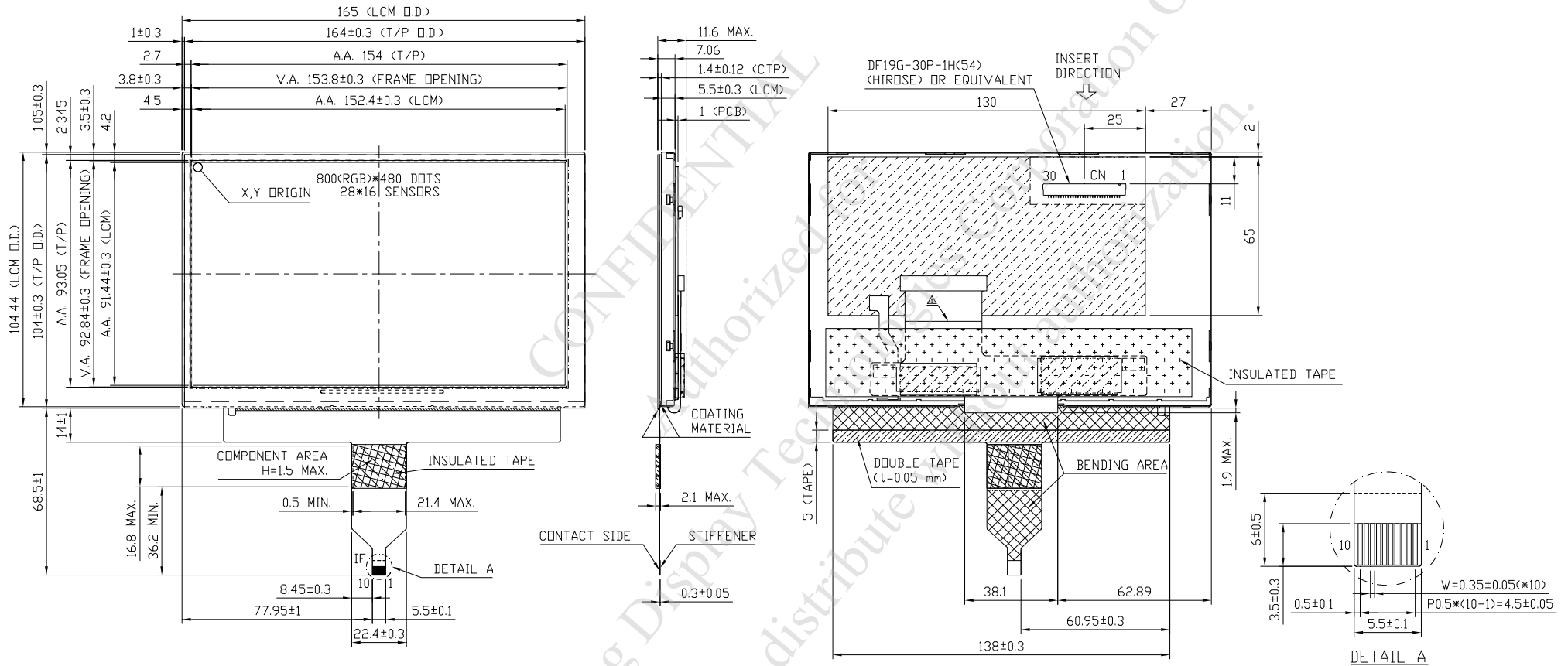

UNIT : mm

SCALE : NTS

NOT SPECIFIED TOLERANCE IS ± 0.5

MARK △ MODIFY (NUMBER NOTE MODIFY VERSION)

NOTE : RECOMMEND MATCH CONNECTOR KYOCERA : 04 6240 010 SERIES

8. BLOCK DIAGRAM

8.1 TFT

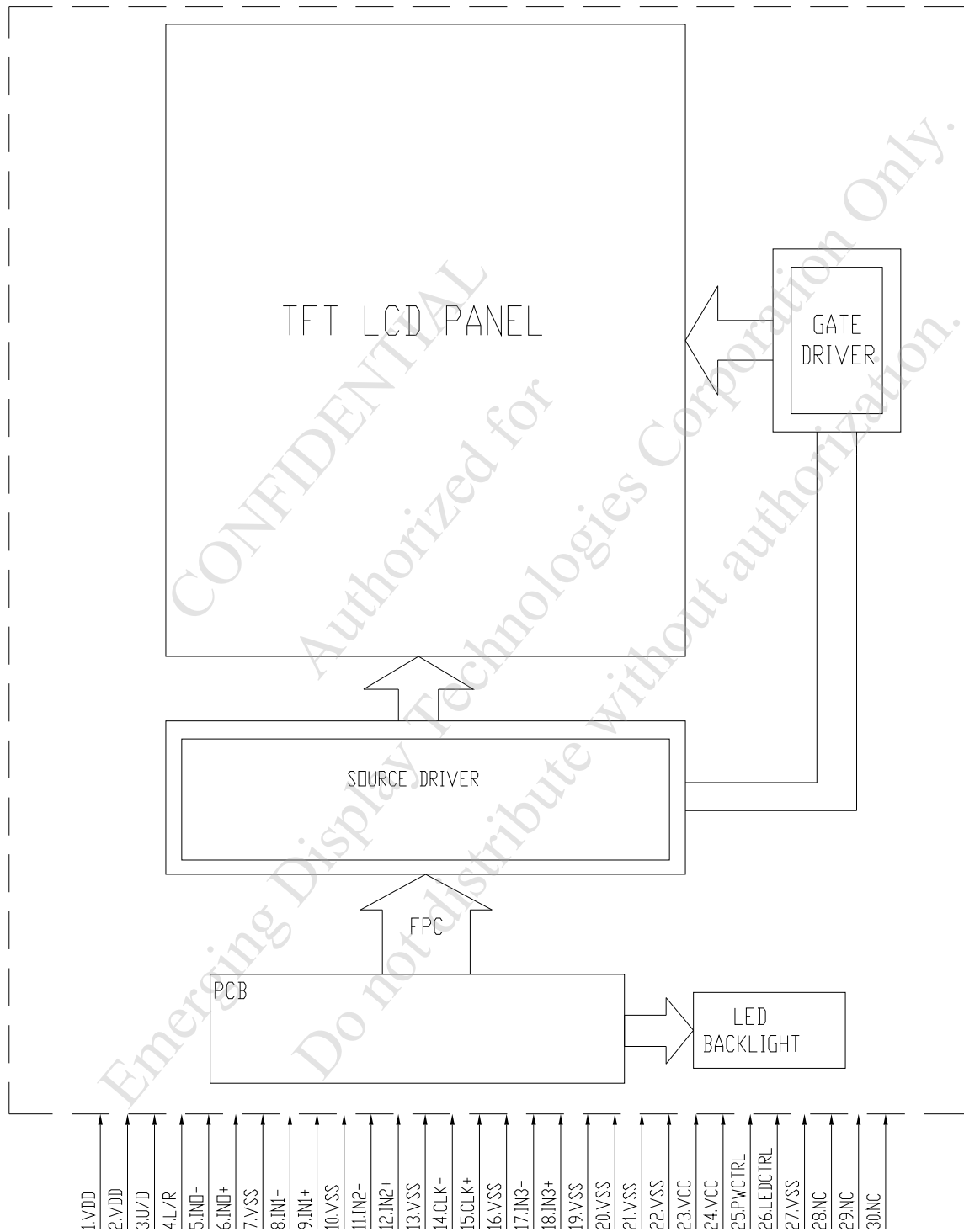

## 8.2 CTP

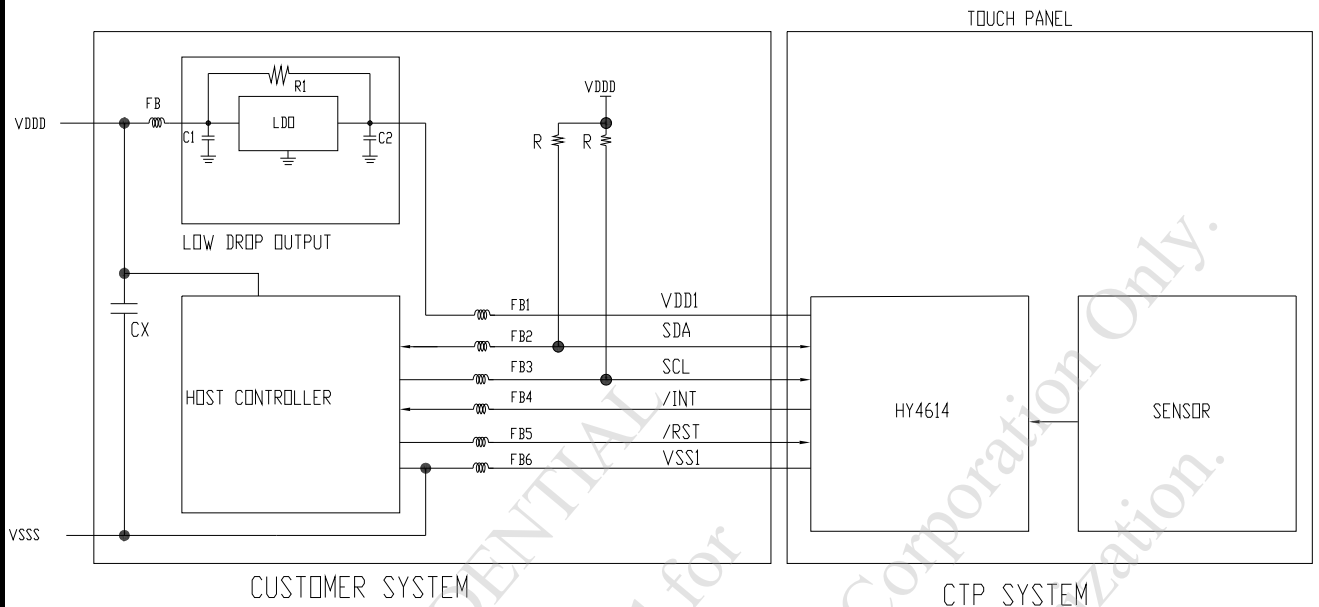

NOTE ( 1 ) : THE STANDARD IIC COMMUNICATION INTERFACE, SUPREME SCL CLOCK IS 400 KHZ, SLAVE ADDRESS CAN BE SET UP, SUPPORTS VDD LEVEL POWER, NEEDS PULL HIGH RESISTANCE AND WE RECOMMEND THE PULL HIGH RESISTANCE IS 2.0K OHM.

NOTE ( 2 ) : POWER SUPPLY SHALL BE CLEAN AND NOISE FREE. ADDITIONAL FILTERING OR A SEPARATE LDO (LOW DROP OUT) REGULATOR CAN BE REQUIRED. C1 AND C2 CAPACITORS RECOMMENDATION : 4.7 $\mu$ F OR 10  $\mu$ F

9. DETAIL DRAWING OF DOT MATRIX

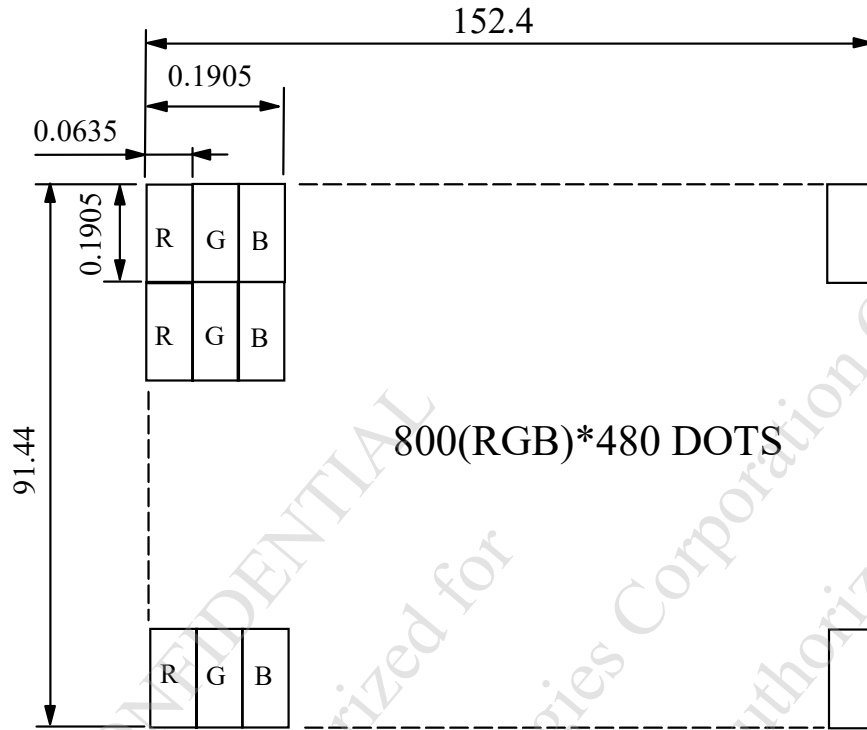

UNIT : mm  
SCALE : NTS  
NOT SPECIFIED TOLERANCE IS  $\pm 0.1$   
DOTS MATRIX TOLERANCE IS  $\pm 0.01$

CONFIDENTIAL  
Authorized for Emerging Display Technologies Corporation Only.  
Do not distribute without authorization.

10. INTERFACE SIGNALS

10.1 TFT

PIN NO.	SYMBOL	FUNCTION								
1	VDD	POWER SUPPLY VOLTAGE								
2	VDD	POWER SUPPLY VOLTAGE								
3	U/D	U/D=H:OUT1→OUT2→..... →OUT480 U/D=L: OUT480→..... → OUT2→OUT1								
4	L/R	L/R=H:OUT1→OUT2→..... →OUT800 L/R=L: OUT800→..... → OUT2→OUT1								
5	INO-	LVDS RECEIVER SIGNAL CHANNEL 0								
6	INO+	LVDS RECEIVER SIGNAL CHANNEL 0								
7	VSS	GROUND(VSS IS CONNECTED TO METAL HOUSING WITH CONDUCTIVE TAPE)								
8	IN1-	LVDS RECEIVER SIGNAL CHANNEL 1								
9	IN1+	LVDS RECEIVER SIGNAL CHANNEL 1								
10	VSS	GROUND(VSS IS CONNECTED TO METAL HOUSING WITH CONDUCTIVE TAPE)								
11	IN2-	LVDS RECEIVER SIGNAL CHANNEL 2								
12	IN2+	LVDS RECEIVER SIGNAL CHANNEL 2								
13	VSS	GROUND(VSS IS CONNECTED TO METAL HOUSING WITH CONDUCTIVE TAPE)								
14	CLK-	LVDS RECEIVER SIGNAL CLOCK								
15	CLK+	LVDS RECEIVER SIGNAL CLOCK								
16	VSS	GROUND(VSS IS CONNECTED TO METAL HOUSING WITH CONDUCTIVE TAPE)								
17	IN3-	LVDS RECEIVER SIGNAL CHANNEL 3								
18	IN3+	LVDS RECEIVER SIGNAL CHANNEL 3								
19	VSS	GROUND(VSS IS CONNECTED TO METAL HOUSING WITH CONDUCTIVE TAPE)								
20	VSS	GROUND(VSS IS CONNECTED TO METAL HOUSING WITH CONDUCTIVE TAPE)								
21	VSS	GROUND(VSS IS CONNECTED TO METAL HOUSING WITH CONDUCTIVE TAPE)								
22	VSS	GROUND(VSS IS CONNECTED TO METAL HOUSING WITH CONDUCTIVE TAPE)								
23	VCC	POWER SUPPLY FOR LED DRIVER CIRCUIT (3.3~5.0V)								
24	VCC	POWER SUPPLY FOR LED DRIVER CIRCUIT (3.3~5.0V)								
25	PWCTRL	<table border="1"> <thead> <tr> <th></th> <th>PWCTRL</th> <th>REMARK</th> </tr> </thead> <tbody> <tr> <td rowspan="2">LOGIC LEVEL H=3.3V L=0V</td> <td>H</td> <td>POWER ON</td> </tr> <tr> <td>L</td> <td>SHUTDOWN</td> </tr> </tbody> </table>		PWCTRL	REMARK	LOGIC LEVEL H=3.3V L=0V	H	POWER ON	L	SHUTDOWN
			PWCTRL	REMARK						
		LOGIC LEVEL H=3.3V L=0V	H	POWER ON						
L	SHUTDOWN									
26	LEDCTRL	BRIGHTNESS CONTROL FOR LED BACKLIGHT : POWER SUPPLY 0~3V OR PWM SIGNAL								
27	VSS	GROUND(VSS IS CONNECTED TO METAL HOUSING WITH CONDUCTIVE TAPE)								
28	NC	NON CONNECTION								
29	NC	NON CONNECTION								
30	NC	NON CONNECTION								

10.2 CTP

PIN NO.	SYMBOL	FUNCTION
1	VSS1	GROUND
2	VDD1	POWER SUPPLY VOLTAGE
3	SCL	I2C CLOCK INPUT
4	NC	NON CONNECTION
5	SDA	I2C DATA INPUT AND OUTPUT
6	NC	NON CONNECTION
7	/RST	EXTERNAL RESET, LOW IS ACTIVE
8	NC	NON CONNECTION
9	/INT	EXTERNAL INTERRUPT TO THE HOST
10	VSS1	GROUND

CONFIDENTIAL  
 Authorized for  
 Emerging Display Technologies Corporation Only  
 Do not distribute without authorization.

## 11. POWER SUPPLY

### 11.1 POWER SUPPLY FOR LCM

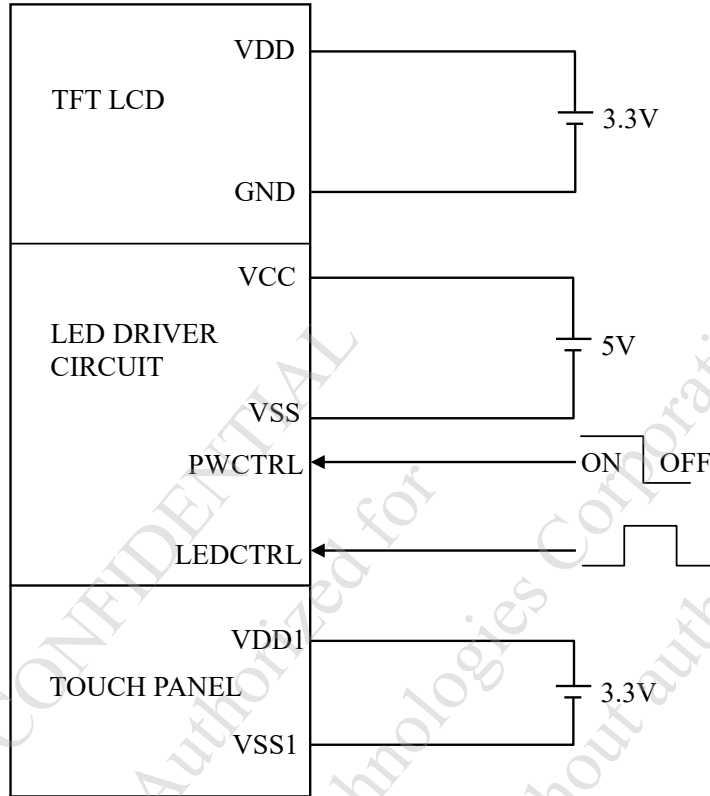

NOTE ( 1 ) : ADJUST THE PWM SIGNAL IN ORDER TO CONTROL LED BACKLIGHT'S BRIGHTNESS. THE HIGHER THE DUTY CYCLE, THE HIGHER THE BRIGHTNESS LUMINANCE

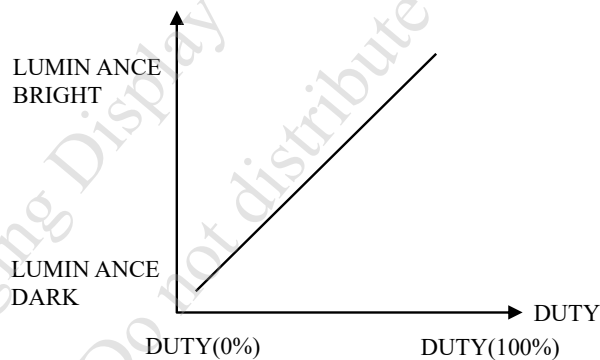

NOTE ( 2 ) : OPERATION FREQUENCY :  $15 \pm 5$  KHz

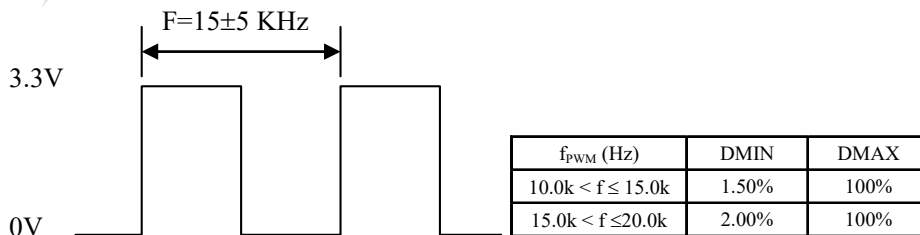

12. CAPACITIVE TOUCH PANEL SPECIFICATION

12.1 OPTICAL CHARACTERISTICS

ITEM	CONDITION	MIN.	TYP.	MAX.	UNIT
TRANSPARENCY NOTE ( 1 )	Ta = 25°C λ = 550nm	85	—	—	%

NOTE ( 1 ) : OPTICAL MEASUREMENT SHOULD BE EXECUTED AFTER PANEL IS SECURED.  
MEASUREMENT PROCESS SHOULD BE EXECUTED IN A STABLE, WINDLESS, AND DARK ROOM.  
OPTICAL SPECIFICATIONS SHOULD BE MEASURED BY SPECTROPHOTOMETER.

12.2 HARDNESS

ITEM	DESCRIPTION
SURFACE HARDNESS	7H (MIN.)

12.3 DURABILITY

USING STEEL BALL AND FALLING ON TOUCH PANEL SURFACE, FROM THE HEIGHT MUST PASS BELOW CONDITIONS :

ITEM	CONDITION	INSPECTION METHOD	DESCRIPTION
STEEL BALL DROP TEST	WEIGHT : 67g HEIGHT OF FALL : 30 cm	VISUAL INSPECTION	SIGN OF FRACTURE OR DAMAGE IS NOT ACCEPTABLE 3 TIMES/ 1 POINTS, 25°C(CENTER TEST)

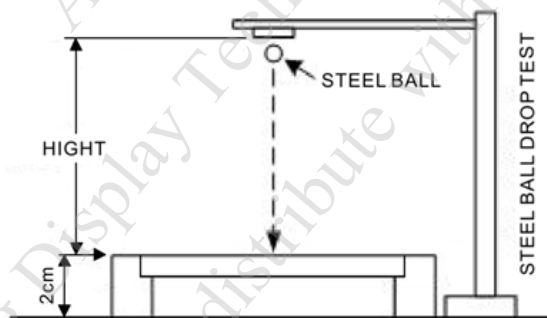

## 12.4 PROTOCOL

### 12.4.1 I2C READ

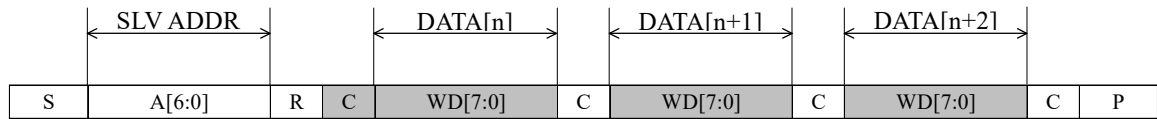

CHARACTER	DESCRIPTION
S	I2C START OR I2C RESTART
A[6:0]	SLAVE ADDRESS, THE VALUE CAN BE CUSTOMIZED
R	OPERATOR BYTE, SHOULD BE 1'b1, STANDS FOR READ
C	ACK SIGNAL
P	STOP SIGNAL (STOP SIGNAL IS OPTIONAL, RESTART SIGNAL IS ALSO OK FOR NEXT PACKET)

SLAVE ADDRESS=0x38

### 12.4.2 INTERRUPT SIGNAL FOR CTPM TO HOST AS FOR STANDARD CTPM, HOST NEED TO USE BOTH INTERRUPT CONTROL SIGNAL AND SERIAL DATA INTERFACE TO GET THE TOUCH DATA.

HERE IS THE TIMING TO GET TOUCH DATA

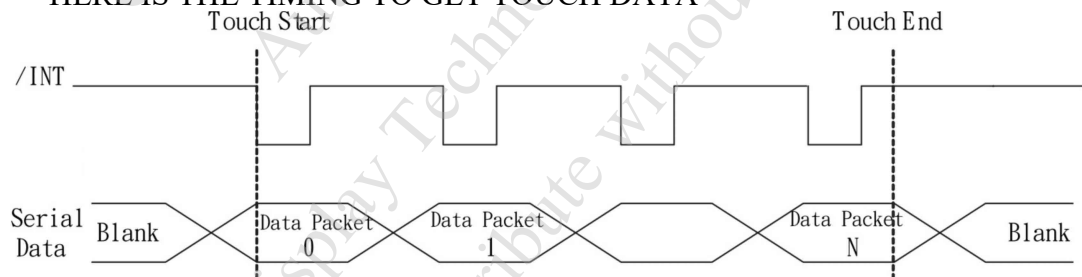

### 12.4.3 READ TOUCH DATA PACKET

WE DEFINED A CTPM PERIOD AS EACH CAPACITANCE DATA GATHERING AND DATA PROCESS, IN EACH CTPM, IF THERE IS A TOUCH DETECTS, THERE WILL WE A FAME OF TOUCH DATA. HOST CAN GET THE SPECIFIED FORMAT TOUCH DATA BY SERIAL DATA INTERFACE.

TOUCH DATA PACKET

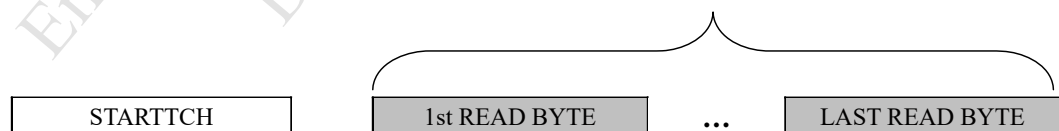

TOUCH DATA FORMAT

TOUCH DATA READ PROTOCOL

IN THIS MODE THE CTP IS FULLY FUNCTIONAL AS A TOUCH SCREEN CONTROLLER. READ AND WRITE ACCESS ADDRESS IS JUST LOGICAL ADDRESS WHICH IS NOT ENFORCED BY HARDWARE OR FIRMWARE. HERE IS THE OPERATING MODE REGISTER MAP.

ADDRESS	NAME	BIT7	BIT6	BIT5	BIT4	BIT3	BIT2	BIT1	BIT0	HOST ACCESS	
02h	TD_STATUS					NUMBER OF TOUCH POINTS[3:0]				R	
03h	TOUCH1_XH	1 <sup>st</sup> EVENT FLAG				1 <sup>st</sup> TOUCH X POSITION[11:8]				R	
04h	TOUCH1_XL	1 <sup>st</sup> TOUCH X POSITION[7:0]								R	
05h	TOUCH1_YH	1 <sup>st</sup> TOUCH ID[3:0]					1 <sup>st</sup> TOUCH Y POSITION[11:8]				R
06h	TOUCH1_YL	1 <sup>st</sup> TOUCH Y POSITION[7:0]								R	
07h											
08h											
09h	TOUCH2_XH	2 <sup>nd</sup> EVENT FLAG				2 <sup>nd</sup> TOUCH X POSITION[11:8]				R	
0Ah	TOUCH2_XL	2 <sup>nd</sup> TOUCH X POSITION[7:0]								R	
0Bh	TOUCH2_YH	2 <sup>nd</sup> TOUCH ID[3:0]					2 <sup>nd</sup> TOUCH Y POSITION[11:8]				R
0Ch	TOUCH2_YL	2 <sup>nd</sup> TOUCH Y POSITION[7:0]								R	
0Dh										R	
0Eh										R	
0Fh	TOUCH3_XH	3 <sup>rd</sup> EVENT FLAG				3 <sup>rd</sup> TOUCH X POSITION[11:8]				R	
10h	TOUCH3_XL	3 <sup>rd</sup> TOUCH X POSITION[7:0]								R	
11h	TOUCH3_YH	3 <sup>rd</sup> TOUCH ID[3:0]					3 <sup>rd</sup> TOUCH Y POSITION[11:8]				R
12h	TOUCH3_YL	3 <sup>rd</sup> TOUCH Y POSITION[7:0]								R	
13h										R	
14h										R	
15h	TOUCH4_XH	4 <sup>th</sup> EVENT FLAG				4 <sup>th</sup> TOUCH X POSITION[11:8]				R	
16h	TOUCH4_XL	4 <sup>th</sup> TOUCH X POSITION[7:0]								R	
17h	TOUCH4_YH	4 <sup>th</sup> TOUCH ID[3:0]					4 <sup>th</sup> TOUCH Y POSITION[11:8]				R
18h	TOUCH4_YL	4 <sup>th</sup> TOUCH Y POSITION[7:0]								R	
19h										R	
1Ah										R	
1Bh	TOUCH5_XH	5 <sup>th</sup> EVENT FLAG				5 <sup>th</sup> TOUCH X POSITION[11:8]				R	
1Ch	TOUCH5_XL	5 <sup>th</sup> TOUCH X POSITION[7:0]								R	
1Dh	TOUCH5_YH	5 <sup>th</sup> TOUCH ID[3:0]					5 <sup>th</sup> TOUCH Y POSITION[11:8]				R
1Eh	TOUCH5_YL	5 <sup>th</sup> TOUCH Y POSITION[7:0]								R	
1Fh										R	
20h										R	
A6h	ID_G_FIRMID	FIRMWARE ID								R	

TD\_STATUS

THIS REGISTER IS THE TOUCH DATA STATUS REGISTER.

ADDRESS	BIT ADDRESS	REGISTER NAME	DESCRIPTION
02h	3:0	NUMBER OF TOUCH POINTS [3:0]	HOW MANY POINTS DETECTED. 1-5 IS VALID.
	7:4	NONE	NONE

TOUCH<sub>n</sub>\_XH (n:1-5)

THIS REGISTER DESCRIBES MSB OF THE X COORDINATE OF THE NTH TOUCH POINT AND THE CORRESPONDING EVENT FLAG.

ADDRESS	BIT ADDRESS	REGISTER NAME	DESCRIPTION
03h ~ 1Bh	7:6	EVENT FLAG	00b: PUT DOWN 01b: PUT UP 10b: CONTACT 11b: RESERVED
	5:4	NONE	RESERVED
	3:0	TOUCH X POSITION [11:8]	MSB OF TOUCH X POSITION IN PIXELS

TOUCH<sub>n</sub>\_XL (n:1-5)

THIS REGISTER DESCRIBES LSB OF THE X COORDINATE OF THE NTH TOUCH POINT.

ADDRESS	BIT ADDRESS	REGISTER NAME	DESCRIPTION
04h ~ 1Ch	7:0	TOUCH X POSITION [7:0]	LSB OF THE TOUCH X POSITION IN PIXELS

TOUCH<sub>n</sub>\_YH (n:1-5)

THIS REGISTER DESCRIBES MSB OF THE Y COORDINATE OF THE NTH TOUCH POINT AND CORRESPONDING TOUCH ID.

ADDRESS	BIT ADDRESS	REGISTER NAME	DESCRIPTION
05h ~ 1Dh	7:4	TOUCH ID [3:0]	TOUCH ID OF TOUCH POINT
	3:0	TOUCH X POSITION [11:8]	MSB OF TOUCH Y POSITION IN PIXELS

TOUCH<sub>n</sub>\_YL (n:1-5)

THIS REGISTER DESCRIBES LSB OF THE Y COORDINATE OF THE NTH TOUCH POINT.

ADDRESS	BIT ADDRESS	REGISTER NAME	DESCRIPTION
06h ~ 1Eh	7:0	TOUCH X POSITION [7:0]	LSB OF THE TOUCH Y POSITION IN PIXELS

ID\_G\_FIRMWARE\_ID

THIS REGISTER DESCRIBES THE FIRMWARE ID OF THE APPLICATION

ADDRESS	BIT ADDRESS	REGISTER NAME	DESCRIPTION
A6h	7:0	ID_G_FIRMWARE_ID	FIRMWARE VERSION

13. INSPECTION CRITERION

13.1 APPLICATION

THIS INSPECTION STANDARD IS TO BE APPLIED TO THE LCD MODULE DELIVERED FROM EMERGING DISPLAY TECHNOLOGIES CORP.( E.D.T ) TO CUSTOMERS

13.2 INSPECTION CONDITIONS

13.2.1 (1)OBSERVATION DISTANCE : 45±5cm

(2)VIEWING ANGLE : ±15°

±15° (FOR SECTION WITHIN VIEWING AREA), REFER TO FIG.A  
90° (FOR SECTION OUTSIDE OF VIEWING AREA), REF TO FIG.B  
PERPENDICULAR TO MODULE SURFACE

VIEWING ANGLE SHOULD BE SMALLER THAN 15°



THE INSPECTION CRITERIA IS ACCORDING TO LINE OF SIGHT. INSPECTION SHALL BE MADE WITHIN THE HALF SECTION OF THE VIEWING CONE GENERATED BY LINE SEGMENT OF 15° WITH RESPECTS TO THE VERTICAL AXIS FROM CENTER VERTEX OF LCD, THE FLUORESCENT LAMP AND THE CONE AXIS MUST BE PERPENDICULAR TO THE LCD SURFACE.

IF THE DEFECTS ARE OUTSIDE OF VIEWING AREA, IT SHALL BE INSPECTED BY 90° WITH RESPECTS TO THE VERTICAL AXIS FROM EDGE OF VIEWING AREA.

13.2.2 ENVIRONMENT CONDITIONS :

AMBIENT TEMPERATURE		25±5°C
AMBIENT HUMIDITY		65±20%RH
AMBIENT ILLUMINATION	COSMETIC INSPECTION	600~800 Lux
	FUNCTIONAL INSPECTION	300~500 Lux
INSPECTION TIME		15 secs

13.2.3 INSPECTION LOT

QUANTITY PER DELIVERY LOT FOR EACH MODEL

13.2.4 INSPECTION METHOD

A SAMPLING INSPECTION SHALL BE MADE ACCORDING TO THE FOLLOWING PROVISIONS TO JUDGE THE ACCEPTABILITY

(a)APPLICABLE STANDARD :

ANSI/ ASQ Z1.4 NORMAL INSPECTION LEVEL II

(b)AQL : MAJOR DEFECT : AQL 0.65

MINOR DEFECT : AQL 1.0

13.3 DEFECTS CLASSIFICATION

TYPE OF DEFECT	INSPECTION ITEM	DEFECT FEATURE	AQL
MAJOR DEFECT	1.DISPLAY ON	<ul style="list-style-type: none"> <li>• DEFECT TO MISS SPECIFIED DISPLAY FUNCTION, FOR ALL AND SPECIFIED DOTS</li> <li>EX: DISCONNECTION, SHORT CIRCUIT ETC</li> </ul>	0.65
	2.CTP FUNCTION	<ul style="list-style-type: none"> <li>• NO FUNCTION</li> <li>• BROKEN LINE</li> <li>• FALSE TOUCH</li> </ul>	
	3.BACKLIGHT	<ul style="list-style-type: none"> <li>• NO LIGHT</li> <li>• FLICKERING AND OTHER ABNORMAL ILLUMINATION</li> </ul>	
	4.DIMENSIONS	<ul style="list-style-type: none"> <li>• SUBJECT TO INDIVIDUAL ACCEPTANCE SPECIFICATIONS</li> </ul>	
MINOR DEFECT	1.DISPLAY ZONE	<ul style="list-style-type: none"> <li>• BLACK/WHITE SPOT / CIRCULAR TYPE</li> <li>• BUBBLES ON POLARIZER</li> <li>• NEWTON RING</li> <li>• BLACK/WHITE LINE / LINEAR TYPE</li> <li>• SCRATCH</li> <li>• CONTAMINATION</li> <li>• UNEVEN COLOR SPREAD</li> </ul>	1.0
	2.BEZEL ZONE	<ul style="list-style-type: none"> <li>• STAINS</li> <li>• SCRATCHES</li> <li>• FOREIGN MATTER</li> </ul>	
	3.SOLDERING	<ul style="list-style-type: none"> <li>• INSUFFICIENT SOLDER</li> <li>• SOLDERED IN INCORRECT POSITION</li> <li>• CONVEX SOLDERING SPOT</li> <li>• SOLDER BALLS</li> <li>• SOLDER SCRAPS</li> </ul>	
	4.DISPLAY ON (ALL ON)	<ul style="list-style-type: none"> <li>• LIGHT LINE</li> </ul>	

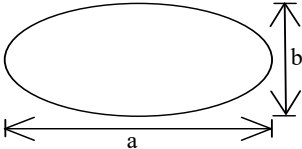
NO.	ITEM	CRITERIA																				
1	DISPLAY ON INSPECTION	1. INCORRECT PATTERN 2. MISSING SEGMENT 3. DIM SEGMENT 4. OPERATING VOLTAGE BEYOND SPEC																				
2	OVERALL DIMENSIONS	1. OVERALL DIMENSION BEYOND SPEC																				
3	DOT DEFECT	<p>(1)INSPECTION PATTERN: FULL WHITE, FULL BLACK, RED, GREEN AND BLUE SCREENS.</p> <p>(2)</p> <table border="1"> <thead> <tr> <th colspan="2">ITEM</th> <th>ACCEPTABLE COUNT</th> </tr> </thead> <tbody> <tr> <td rowspan="3">BRIGHT DOT</td> <td>RANDOM</td> <td>N = 3</td> </tr> <tr> <td>2 DOTS ADJACENT (PAIR)</td> <td>N = 0</td> </tr> <tr> <td>3 DOTS ADJACENT OR MORE</td> <td>N = 0</td> </tr> <tr> <td rowspan="3">DARK DOT</td> <td>RANDOM</td> <td>N ≤ 5</td> </tr> <tr> <td>2 DOTS ADJACENT (PAIR)</td> <td>N = 0</td> </tr> <tr> <td>3 DOTS ADJACENT OR MORE</td> <td>N = 0</td> </tr> <tr> <td colspan="2">TOTAL BRIGHT AND DARK DOT</td> <td>N ≤ 5</td> </tr> </tbody> </table> <p>NOTE :</p> <ol style="list-style-type: none"> <li>1. THE DEFINITION OF DOT : THE SIZE OF A DEFECTIVE DOT OVER 1/2 OF WHOLE DOT IS REGARDED AS ONE DEFECTIVE DOT. THE BRIGHT DOT DEFECT MOST BE VISIBLE THROUGH A 5% ND FILTER</li> <li>2. BRIGHT DOT : DOTS APPEAR BRIGHT AND UNCHANGED IN SIZE IN WHICH LCD PANEL IS DISPLAYING UNDER BLACK PATTERN.</li> <li>3. DARK DOT : DOTS APPEAR DARK AND UNCHANGED IN SIZE IN WHICH LCD PANEL IS DISPLAYING UNDER PURE RED, GREEN, BLUE PICTURE.</li> </ol>	ITEM		ACCEPTABLE COUNT	BRIGHT DOT	RANDOM	N = 3	2 DOTS ADJACENT (PAIR)	N = 0	3 DOTS ADJACENT OR MORE	N = 0	DARK DOT	RANDOM	N ≤ 5	2 DOTS ADJACENT (PAIR)	N = 0	3 DOTS ADJACENT OR MORE	N = 0	TOTAL BRIGHT AND DARK DOT		N ≤ 5
ITEM		ACCEPTABLE COUNT																				
BRIGHT DOT	RANDOM	N = 3																				
	2 DOTS ADJACENT (PAIR)	N = 0																				
	3 DOTS ADJACENT OR MORE	N = 0																				
DARK DOT	RANDOM	N ≤ 5																				
	2 DOTS ADJACENT (PAIR)	N = 0																				
	3 DOTS ADJACENT OR MORE	N = 0																				
TOTAL BRIGHT AND DARK DOT		N ≤ 5																				
4	BUBBLES ON POLARIZER /SURFACE STAINS /DIRT/CF FAIL/SPOT	<table border="1"> <thead> <tr> <th></th> <th>AVERAGE DIAMETER (mm) : D</th> <th>PERMISSIBLE NO.</th> </tr> </thead> <tbody> <tr> <td rowspan="3">BUBBLE ON POLARIZER</td> <td>D ≤ 0.15</td> <td>IGNORE</td> </tr> <tr> <td>0.15 &lt; D ≤ 0.5</td> <td>N ≤ 4</td> </tr> <tr> <td>0.5 &lt; D</td> <td>0</td> </tr> <tr> <td rowspan="2">SURFACE STAINS / DIRT ON POLARIZER</td> <td>D ≤ 0.1</td> <td>IGNORE</td> </tr> <tr> <td>0.1 &lt; D ≤ 0.5</td> <td>N ≤ 4</td> </tr> <tr> <td rowspan="2">CF FAIL / SPOT</td> <td>D ≤ 0.1</td> <td>IGNORE</td> </tr> <tr> <td>0.1 &lt; D ≤ 0.5</td> <td>N ≤ 4</td> </tr> </tbody> </table> <p>NOTE : (1)POLARIZER BUBBLE IS DEFINED AS THE BUBBLE APPEARS ON ACTIVE DISPLAY AREA. THE DEFECT OF POLARIZER BUBBLE SHALL BE IGNORED IF THE POLARIZER BUBBLE APPEARS ON THE OUTSIDE OF ACTIVE DISPLAY AREA.</p> <p>(2)THE EXTRANEIOUS SUBSTANCE IS DEFINED AS IT CAN BE OBSERVED WHEN THE MODULE IS POWER ON.</p> <p>(3)THE DEFINITION OF AVERAGE DIAMETER, D IS DEFINED AS FOLLOWING.</p> <p>AVERAGE DIAMETER (D)=(a+b)/2</p> 		AVERAGE DIAMETER (mm) : D	PERMISSIBLE NO.	BUBBLE ON POLARIZER	D ≤ 0.15	IGNORE	0.15 < D ≤ 0.5	N ≤ 4	0.5 < D	0	SURFACE STAINS / DIRT ON POLARIZER	D ≤ 0.1	IGNORE	0.1 < D ≤ 0.5	N ≤ 4	CF FAIL / SPOT	D ≤ 0.1	IGNORE	0.1 < D ≤ 0.5	N ≤ 4
	AVERAGE DIAMETER (mm) : D	PERMISSIBLE NO.																				
BUBBLE ON POLARIZER	D ≤ 0.15	IGNORE																				
	0.15 < D ≤ 0.5	N ≤ 4																				
	0.5 < D	0																				
SURFACE STAINS / DIRT ON POLARIZER	D ≤ 0.1	IGNORE																				
	0.1 < D ≤ 0.5	N ≤ 4																				
CF FAIL / SPOT	D ≤ 0.1	IGNORE																				
	0.1 < D ≤ 0.5	N ≤ 4																				

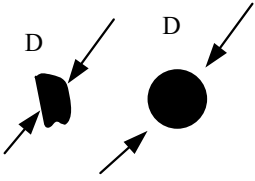
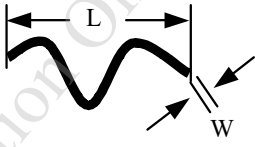
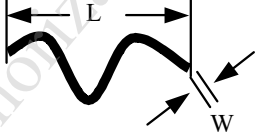
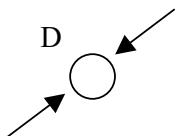
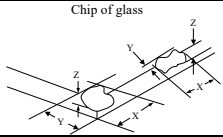
NO.	ITEM	CRITERIA												
5	BLACK/WHITE SPOT CIRCULAR TYPE	<p>THE FOLLOWING BLACK/WHITE SPOT ARE WITHIN THE VIEWING AREA. AVERAGE DIAMETER : D (mm)</p> <table border="1"> <thead> <tr> <th>SIZE D</th> <th>PERMISSIBLE NO.</th> </tr> </thead> <tbody> <tr> <td>D≤0.1</td> <td>IGNORE</td> </tr> <tr> <td>0.1&lt;D≤0.3</td> <td>5</td> </tr> <tr> <td>0.3&lt;D≤0.5</td> <td>5</td> </tr> <tr> <td>D&gt;0.5</td> <td>0</td> </tr> </tbody> </table> <p>NOTE ( 1 ) : THE DISTANCE BETWEEN DEFECTS SHOULD BE MORE THAN 10mm APART.</p>		SIZE D	PERMISSIBLE NO.	D≤0.1	IGNORE	0.1<D≤0.3	5	0.3<D≤0.5	5	D>0.5	0	
SIZE D	PERMISSIBLE NO.													
D≤0.1	IGNORE													
0.1<D≤0.3	5													
0.3<D≤0.5	5													
D>0.5	0													
6	SCRATCH	<p>THE FOLLOWING SCRATCH IS WITHIN THE VIEWING AREA. WIDTH : W (mm) , LENGTH : L (mm)</p> <table border="1"> <thead> <tr> <th>SIZE W &amp; L</th> <th>PERMISSIBLE NO.</th> </tr> </thead> <tbody> <tr> <td>W≤0.05</td> <td>IGNORE</td> </tr> <tr> <td>0.05&lt;W≤0.08, L≤8</td> <td>3</td> </tr> <tr> <td>0.08&lt;W≤0.1, L≤5</td> <td>2</td> </tr> <tr> <td>W&gt;0.1</td> <td>0</td> </tr> </tbody> </table> <p>NOTE ( 1 ) : THE DISTANCE BETWEEN DEFECTS SHOULD BE MORE THAN 10mm APART.</p>		SIZE W & L	PERMISSIBLE NO.	W≤0.05	IGNORE	0.05<W≤0.08, L≤8	3	0.08<W≤0.1, L≤5	2	W>0.1	0	
SIZE W & L	PERMISSIBLE NO.													
W≤0.05	IGNORE													
0.05<W≤0.08, L≤8	3													
0.08<W≤0.1, L≤5	2													
W>0.1	0													
7	BLACK / WHITE LINE LINEAR TYPE / FOREIGN FIBER	<p>THE FOLLOWING BLACK LINE, WHITE LINE IS WITHIN THE VIEWING AREA. WIDTH : W (mm) , LENGTH : L (mm)</p> <table border="1"> <thead> <tr> <th>SIZE W &amp; L</th> <th>PERMISSIBLE NO.</th> </tr> </thead> <tbody> <tr> <td>W≤0.05</td> <td>IGNORE</td> </tr> <tr> <td>0.05&lt;W≤0.08, L≤8</td> <td>3</td> </tr> <tr> <td>0.08&lt;W≤0.1, L≤5</td> <td>2</td> </tr> <tr> <td>W&gt;0.1</td> <td>0</td> </tr> </tbody> </table> <p>NOTE ( 1 ) : THE DISTANCE BETWEEN DEFECTS SHOULD BE MORE THAN 10mm APART.</p>		SIZE W & L	PERMISSIBLE NO.	W≤0.05	IGNORE	0.05<W≤0.08, L≤8	3	0.08<W≤0.1, L≤5	2	W>0.1	0	
SIZE W & L	PERMISSIBLE NO.													
W≤0.05	IGNORE													
0.05<W≤0.08, L≤8	3													
0.08<W≤0.1, L≤5	2													
W>0.1	0													
8	BUBBLE / DENT FOR OPTICAL BONDING	<p>BUBBLES WITHIN VIEWING AREA. AVERAGE DIAMETER : D (mm)</p> <table border="1"> <thead> <tr> <th>SIZE D</th> <th>PERMISSIBLE NO.</th> </tr> </thead> <tbody> <tr> <td>D≤0.2</td> <td>IGNORE</td> </tr> <tr> <td>0.2&lt;D≤0.3</td> <td>3</td> </tr> <tr> <td>0.3&lt;D≤0.5</td> <td>2</td> </tr> <tr> <td>D&gt;0.5</td> <td>0</td> </tr> </tbody> </table> <p>NOTE ( 1 ) : THE DISTANCE BETWEEN DEFECTS SHOULD BE MORE THAN 10mm APART.</p>		SIZE D	PERMISSIBLE NO.	D≤0.2	IGNORE	0.2<D≤0.3	3	0.3<D≤0.5	2	D>0.5	0	
SIZE D	PERMISSIBLE NO.													
D≤0.2	IGNORE													
0.2<D≤0.3	3													
0.3<D≤0.5	2													
D>0.5	0													
9	CHIPPING	<table border="1"> <tr> <td>CORNER</td> <td>X ≤ 3mm 、 Y ≤ 3mm 、 Z ≤ t (t : THICKNESS)</td> </tr> <tr> <td>EDGE</td> <td>X ≤ 6mm , Y ≤ 1mm , Z &lt; t (t : THICKNESS)</td> </tr> </table>	CORNER	X ≤ 3mm 、 Y ≤ 3mm 、 Z ≤ t (t : THICKNESS)	EDGE	X ≤ 6mm , Y ≤ 1mm , Z < t (t : THICKNESS)								
CORNER	X ≤ 3mm 、 Y ≤ 3mm 、 Z ≤ t (t : THICKNESS)													
EDGE	X ≤ 6mm , Y ≤ 1mm , Z < t (t : THICKNESS)													
10	CRACKED GLASS	NOT ACCEPTABLE												
11	LINE DEFECT ON DISPLAY	OBVIOUS VERTICAL OR HORIZONTAL LINE DEFECT IS NOT ALLOWED.												
12	MURA ON DISPLAY	NOT VISIBLE THROUGH 5% ND FILTER OR JUDGED BY LIMIT SAMPLE IF NECESSARY.												
13	UNEVEN COLOR SPREAD, COLORATION	TO BE DETERMINED BASED UPON THE LIMITED SAMPLE.												
14	BEZEL APPEARANCE	<p>1. BEZEL MAY NOT HAVE RUST, BE DEFORMED OR HAVE FINGER PRINTS STAINS OF OTHER CONTAMINATION.</p> <p>2. BEZEL MUST COMPLY WITH JOB SPECIFICATIONS.</p>												

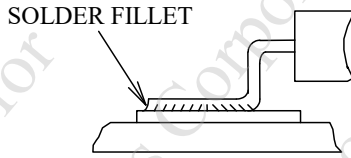
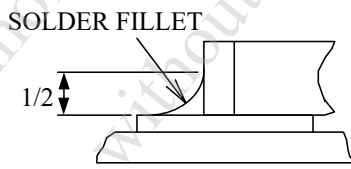
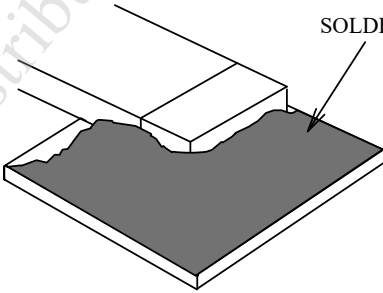
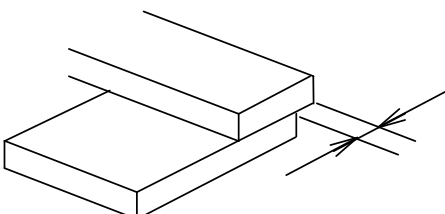
NO.	ITEM	CRITERIA
15	PCB	<ol style="list-style-type: none"> <li>1. THERE MAY NOT BE MORE THAN 2mm OF SEALANT OUTSIDE THE SEAL AREA ON THE PCB, AND THERE SHOULD BE NO MORE THAN THREE PLACES.</li> <li>2. NO OXIDATION OR CONTAMINATION ON PCB TERMINALS.</li> <li>3. PARTS ON PCB MUST BE THE SAME AS ON THE PRODUCTION CHARACTERISTIC CHART. THERE SHOULD BE NO WRONG PARTS, MISSING PARTS OR EXCESS PARTS.</li> <li>4. THE JUMPER ON THE PCB SHOULD CONFORM TO THE PRODUCT CHARACTERISTIC CHART.</li> <li>5. IF SOLDER GETS ON BEZEL TAB PADS, LED PAD, ZEBRA PAD OR SCREW HOLD PAD; MAKE SURE IT IS SMOOTHED DOWN.</li> </ol>
16	SOLDERING	<ol style="list-style-type: none"> <li>1. NO SOLDERING FOUND ON THE SPECIFIED PLACE</li> <li>2. INSUFFICIENT SOLDER               <ol style="list-style-type: none"> <li>(a)LSI, IC A POOR WETTING OF SOLDER IS BETWEEN LOWER BEND OR "HEEL" OF LEAD AND PAD   </li> <li>(b)CHIP COMPONENT  <ul style="list-style-type: none"> <li>· SOLDER IS LESS THAN 50% OF SIDES AND FRONT FACE WETTING   </li> <li>· SOLDER WETS 3 SIDES OF TERMINAL, BUT LESS THAN 25% OF SIDES AND FRONT SURFACE AREA ARE COVERED   </li> </ul> </li> </ol> </li> <li>3. PARTS ALIGNMENT               <ol style="list-style-type: none"> <li>(a)LSI, IC LEAD WIDTH IS MORE THAN 50% BEYOND PAD OUTLINE   </li> </ol> </li> </ol>

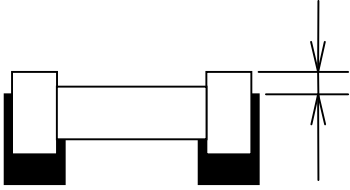
NO.	ITEM	CRITERIA
16	SOLDERING	<p>(b)CHIP COMPONENT COMPONENT IS OFF CENTER, AND MORE THAN 50% OF THE LEADS IS OFF THE PAD OUTLINE</p>  <p>4. NO UNMELTED SOLDER PASTE MAY BE PRESENT ON THE PCB. 5. NO COLD SOLDER JOINTS, MISSING SOLDER CONNECTIONS, OXIDATION OR ICICLE. 6. NO RESIDUE OR SOLDER BALLS ON PCB. 7. NO SHORT CIRCUITS IN COMPONENTS ON PCB.</p>
17	BACKLIGHT	<p>1. NO LIGHT 2. FLICKERING AND OTHER ABNORMAL ILLUMINATION 3. SPOTS OR SCRATCHES THAT APPEAR WHEN LIT MUST BE JUDGED USING LCD SPOT, LINES AND CONTAMINATION STANDARDS. 4. BACKLIGHT DOESN'T LIGHT OR COLOR IS WRONG.</p>
18	GENERAL APPEARANCE	<p>1. NO OXIDATION, CONTAMINATION, CURVES OR, BENDS ON INTERFACE PIN (OLB) OF TCP. 2. NO CRACKS ON INTERFACE PIN (OLB) OF TCP. 3. NO CONTAMINATION, SOLDER RESIDUE OR SOLDER BALLS ON PRODUCT. 4. THE IC ON THE TCP MAY NOT BE DAMAGED, CIRCUITS. 5. THE UPPERMOST EDGE OF THE PROTECTIVE STRIP ON THE INTERFACE PIN MUST BE PRESENT OR LOOK AS IF IT CAUSE THE INTERFACE PIN TO SEVER. 6. THE RESIDUAL ROSIN OR TIN OIL OF SOLDERING (COMPONENT OR CHIP COMPONENT) IS NOT BURNED INTO BROWN OR BLACK COLOR. 7. SEALANT ON TOP OF THE ITO CIRCUIT HAS NOT HARDENED. 8. PIN TYPE MUST MATCH TYPE IN SPECIFICATION SHEET. 9. LCD PIN LOOSE OR MISSING PINS. 10. PRODUCT PACKAGING MUST BE THE SAME AS SPECIFIED ON PACKAGING SPECIFICATION SHEET. 11. PRODUCT DIMENSION AND STRUCTURE MUST CONFORM TO PRODUCT SPECIFICATION SHEET. 12. THE APPEARANCE OF HEAT SEAL SHOULD NOT ADMIT ANY DIRT AND BREAK.</p>

NOTE :

1. FOR ANY SPOTS OR LINES, WHICH ARE NOT OBSERVED UNDER APPROPRIATE PANEL OPERATING CONDITION ARE DEEMED ACCEPTABLE.
2. THE FOREIGN MATERIALS THAT CAN BE BLOWN OUT BY AIR AND REMOVED BY WET CLEANING ARE NOT REGARDED AS DEFECTS.

14. RELIABILITY TEST

14.1 STANDARD SPECIFICATIONS FOR RELIABILITY OF LCD ODULE

NO.	ITEM	DESCRIPTION
1	HIGH TEMPERATURE OPERATION	THE SAMPLE SHOULD BE ALLOWED TO STAND AT +85°C FOR 240 HRS
2	LOW TEMPERATURE OPERATION	THE SAMPLE SHOULD BE ALLOWED TO STAND AT -30°C FOR 240 HRS
3	HIGH TEMPERATURE STORAGE	THE SAMPLE SHOULD BE ALLOWED TO STAND AT +85°C FOR 240 HRS
4	LOW TEMPERATURE STORAGE	THE SAMPLE SHOULD BE ALLOWED TO STAND AT -30°C FOR 240 HRS
5	HIGH TEMPERATURE / HUMIDITY TEST STORAGE	THE SAMPLE SHOULD BE ALLOWED TO STAND AT 60°C, 90% RH 240 HRS
6	THERMAL SHOCK (NOT OPERATED)	<p>THE SAMPLE SHOULD BE ALLOWED TO STAND THE FOLLOWING 10 CYCLES OF OPERATION :</p>
7	ESD (ELECTROSTATIC DISCHARGE) (NOT OPERATED)	HUMAN BODY MODEL C=100pF, R=1.5KΩ; DISCHARGE: ±2KV

NOTE ( 1 ) : THE TEST SAMPLES HAVE RECOVERY TIME FOR 2 HOURS AT ROOM TEMPERATURE BEFORE THE FUNCTION CHECK. IN THE STANDARD CONDITIONS, THERE IS NO DISPLAY FUNCTION NG ISSUE OCCURRED.

NOTE ( 2 ) : WHEN THE LCD MODULE IS OPERATED AT A HIGHER AMBIENT TEMPERATURE THAN 60°C, THE PWM DUTY CYCLE OF THE LED BACKLIGHT SHOULD BE ADJUSTED TO BE LESS THAN 70%. IF THE MODULE IS OPERATED AT A HIGHER DUTY CYCLE THAN 70%, THEN THERE IS A POSSIBILITY OF DISTORTION AND IRREGULARITY OF THE PICTURE DUE TO LIQUID CRYSTAL BEHAVIOR.

14.2 TESTING CONDITIONS AND INSPECTION CRITERIA

FOR THE FINAL TEST THE TESTING SAMPLE MUST BE STORED AT ROOM TEMPERATURE FOR 24 HOURS, AFTER THE TESTS LISTED IN TABLE 14.2, STANDARD SPECIFICATIONS FOR RELIABILITY HAVE BEEN EXECUTED IN ORDER TO ENSURE STABILITY.

NO.	ITEM	TEST MODEL	INSPECTION CRITERIA
1	CURRENT CONSUMPTION	REFER TO SPECIFICATION	THE CURRENT CONSUMPTION SHOULD CONFORM TO THE PRODUCT SPECIFICATION.
2	CONTRAST	REFER TO SPECIFICATION	AFTER THE TESTS HAVE BEEN EXECUTED, THE CONTRAST MUST BE LARGER THAN HALF OF ITS INITIAL VALUE PRIOR TO THE TESTS.
3	APPEARANCE	VISUAL INSPECTION	DEFECT FREE

## 15. CAUTION

### 15.1 OPERATION

- 15.1.1 DO NOT CONNECT OR DISCONNECT MODULES TO OR FROM THE MAIN SYSTEM WHILE POWER IS BEING SUPPLIED .
- 15.1.2 USE THE MODULE WITHIN SPECIFIED TEMPERATURE ; LOWER TEMPERATURE CAUSES THE RETARDATION OF BLINKING SPEED OF THE DISPLAY ; HIGHER TEMPERATURE MAKES OVERALL DISPLAY DISCOLOR. WHEN THE TEMPERATURE RETURNS TO NORMALITY, THE DISPLAY WILL OPERATE NORMALLY .
- 15.1.3 ADJUST THE LC DRIVING VOLTAGE TO OBTAIN THE OPTIMUM CONTRAST.
- 15.1.4 POWER ON SEQUENCE INPUT SIGNALS SHOULD NOT BE SUPPLIED TO LCD MODULE BEFORE POWER SUPPLY VOLTAGE IS APPLIED AND REACHES THE SPECIFIED VALUE .  
IF ABOVE SEQUENCE IS NOT FOLLOWED , CMOS LSIS OF LCD MODULES MAY BE DAMAGED DUE TO LATCH - UP PROBLEM .
- 15.1.5 NOT ALLOWED TO INFLICT ANY EXTERNAL STRESS AND TO CAUSE ANY MECHANICAL INTERFERENCE ON THE BENDING AREA OF FPC DURING THE TAIL BENDING BACKWARDS!  
DO NOT STRESS FPC AND IC ON THE MODULE!

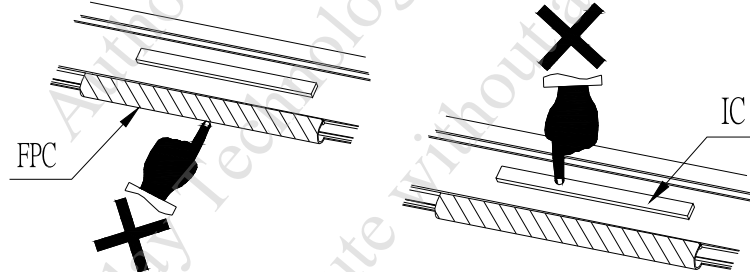

## 15.2 HANDLING

- 15.2.1 USE A GROUNDED SOLDERING IRON WHEN SOLDERING CONNECTOR I/O TERMINALS . FOR SOLDERING OR REPAIRING, TAKE PRECAUTION AGAINST THE TEMPERATURE OF THE SOLDERING IRON AND THE SOLDERING TIME TO PREVENT PEELING OFF THE THROUGH-HOLE-PAD .
- 15.2.2 DO NOT DISASSEMBLE . EDT SHALL NOT BE HELD RESPONSIBLE IF THE MODULE IS DISASSEMBLED AND UPON THE REASSEMBLY THE MODULE FAILED .
- 15.2.3 DO NOT CHARGE STATIC ELECTRICITY , AS THE CIRCUIT OF THIS MODULE CONTAINS CMOS LSIS. A WORKMAN'S BODY SHOULD ALWAYS BE STATIC-PROTECTED BY USE OF AN ESD STRAP. WORKING CLOTHES FOR SUCH PERSONNEL SHOULD BE OF STATIC-PROTECTED MATERIAL .
- 15.2.4 ALWAYS GROUND THE ELECTRICALLY-POWERED DRIVER BEFORE USING IT TO INSTALL THE LCD MODULE. WHILE CLEANING THE WORK STATION BY VACUUM CLEANER, DO NOT BRING THE SUCKING MOUTH NEAR THE MODULE ; STATIC ELECTRICITY OF THE ELECTRICALLY-POWERED DRIVER OR THE VACUUM CLEANER MAY DESTROY THE MODULE .
- 15.2.5 DON'T GIVE EXTERNAL SHOCK.
- 15.2.6 DON'T APPLY EXCESSIVE FORCE ON THE SURFACE.
- 15.2.7 LIQUID CRISTAL IN LCD IS HAZARDOUS SUBSTANCE. MUST NOT LICK AND SWALLOW.  
WHEN THE LIQUID IS ATTACH TO YOUR, SKIN, CLOTH ETC.  
WASH IT OUT THOROUGHLY AND IMMEDIATELY.
- 15.2.8 DON'T OPERATE IT ABOVE THE ABSOLUTE MAXIMUM RATING.
- 15.2.9 STORAGE IN A CLEAN ENVIRONMENT, FREE FROM DUST, ACTIVE GAS, AND SOLVENT.
- 15.2.10 STORE WITHOUT ANY PHYSICAL LOAD.
- 15.2.11 REWIRING: NO MORE THAN 3 TIMES.