



MULTI-INNO TECHNOLOGY CO., LTD.

[www.multi-inno.com](http://www.multi-inno.com)

## LCD MODULE SPECIFICATION

**Model: MI0700S6T-1-HB**

This module is ROHS compliant

### For Customer's Acceptance:

Customer	
Approved by	
Comment	

The standard product specification may change without prior notice in order to improve performance or quality. Please contact Multi-Inno for updated specification and product status before design for the standard product or release of the order.

Revision	1.5
Engineering	
Date	2021-10-27
Our Reference	





# CONTENTS

- REVISION RECORD
- GENERAL INFORMATION
- EXTERNAL DIMENSIONS
- PCBA PHOTO
- ABSOLUTE MAXIMUM RATINGS
- ELECTRICAL CHARACTERISTICS
- ELECTRO-OPTICAL CHARACTERISTICS
- INTERFACE DESCRIPTION
- APPLICATION NOTES
- RELIABILITY TEST
- INSPECTION CRITERION
- PRECAUTIONS FOR USING LCD MODULES
- PRIOR CONSULT MATTER

**■ GENERAL INFORMATION**

Item	Specification	Unit
LCD Type	TFT / Transmissive / Normally white	/
Size	7.0	Inch
Viewing Direction	12:00 (without image inversion and least brightness change)	O'clock
Gray Scale Inversion Direction	6:00 (contrast peak located at)	O'clock
LCM (W × H × D)	164.90 × 99.80 × 9.10 (exclude component area)	mm <sup>3</sup>
Active Area (W × H)	154.08 × 85.92	mm <sup>2</sup>
Pixel Pitch	0.1926 × 0.1790	mm <sup>2</sup>
Number of Dots	800 (RGB) × 480	/
Driver IC	RTD2660H	/
Backlight Type	21LEDs	/
Interface Type	(1) HDMI (for display signal input)	/
	(2) -	
Color Depth	16.7M	/
Pixel Configuration	R.G.B Vertical Stripe	/
Top Polarizer Surface Treatment	Anti-glare	/
Input Voltage	12.0	V
With / Without TSP	Without TSP	/
TP Surface Treatment	-	/
Weight	TBD	g

Note 1: ROHS compliant;

Note 2: LCM weight tolerance: ±5%.

**EXTERNAL DIMENSIONS**

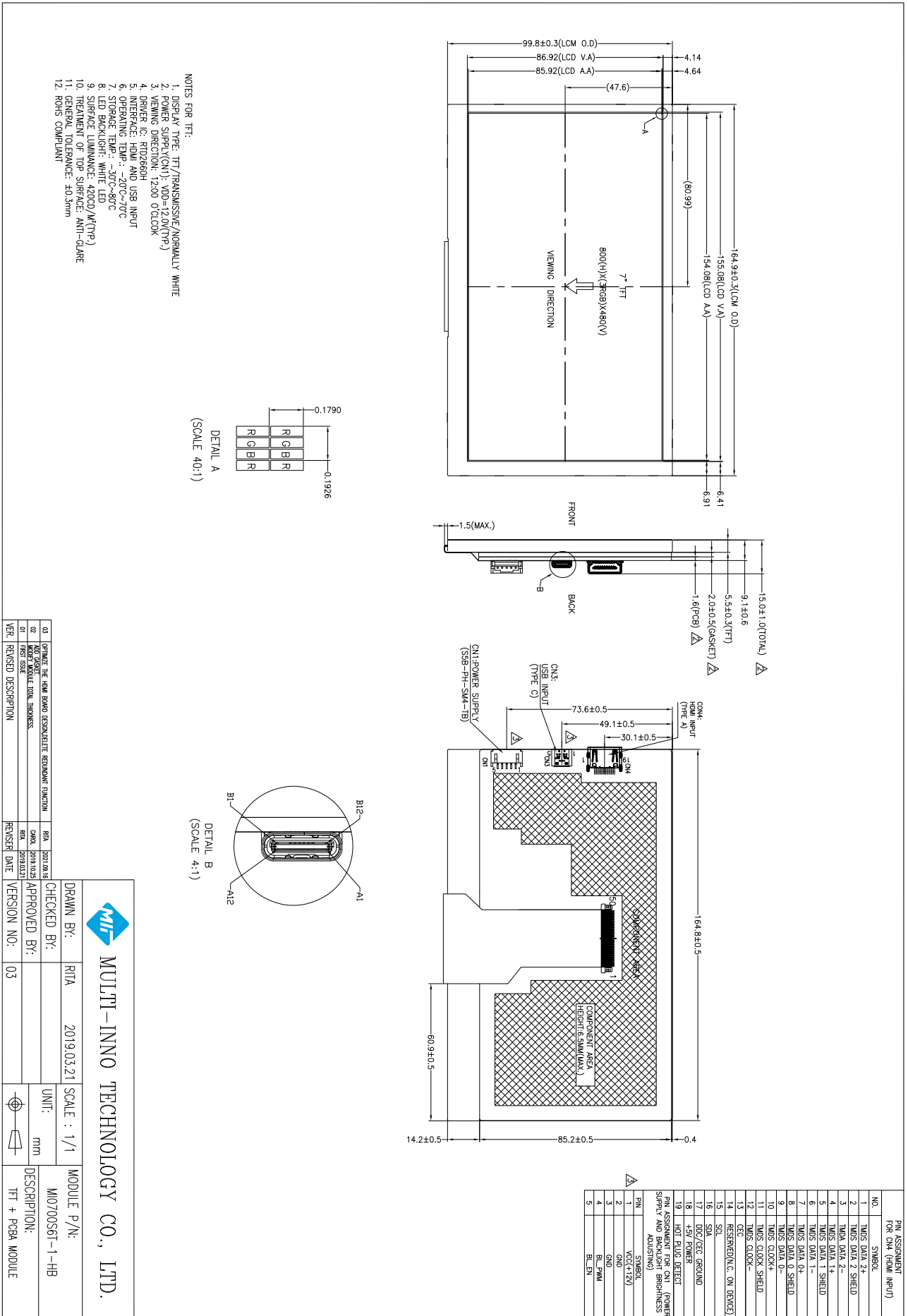

## ■ PCBA PHOTO

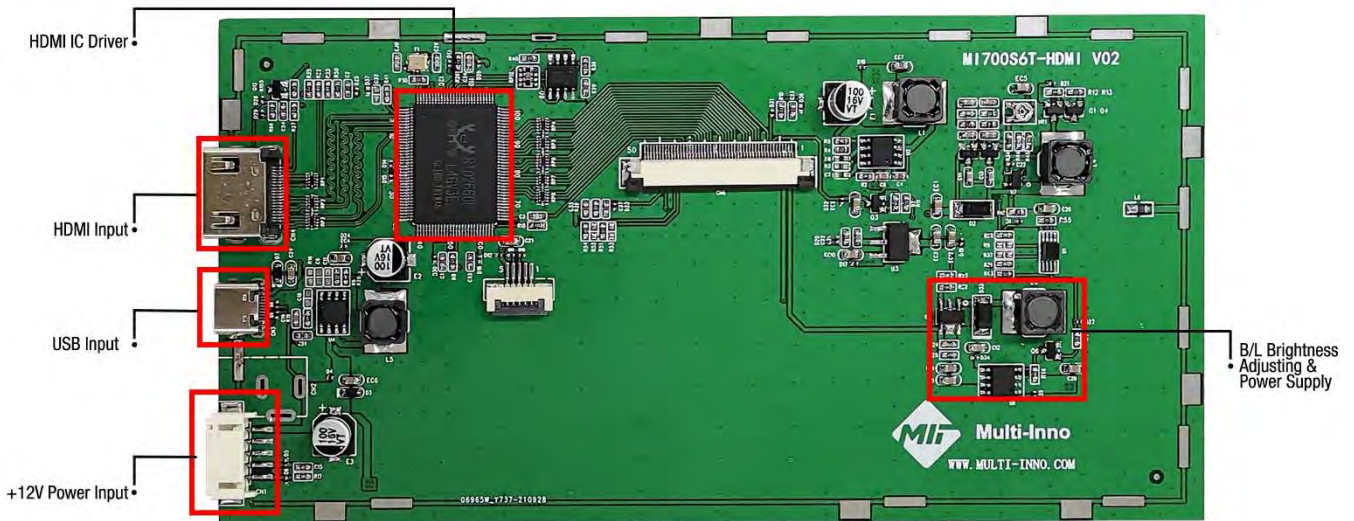

## ■ ABSOLUTE MAXIMUM RATINGS

Parameter	Symbol	Min.	Max.	Unit
Operating Temperature	T <sub>OP</sub>	-20	70	°C
Storage Temperature	T <sub>ST</sub>	-30	80	°C

## ■ ELECTRICAL CHARACTERISTICS

T<sub>a</sub>=25±2°C, 60%RH±5%

Parameter	Symbol	Min.	Typ.	Max.	Unit	Notes
Power Supply Voltage	DC	10	12	14	V	
Operating Current	-	-	245	-	mA	
BL_PWM Dimming Frequency	-	1	-	20	KHz	
BL_EN Logic High Level	VENH	2.5	-	3.3	V	Backlight ON
BL_EN Logic Low Level	VENL	-	-	0.3	V	Backlight OFF
BL_PWM Logic High Level	VPMH	2.5	-	3.3	V	
BL_PWM Logic Low Level	VPML	-	-	0.3	V	
BL_PWM Duty Ratio	-	5	-	100	%	
Operating Life Time	-	30000	50000	-	Hrs	Note 1

Note: Operating life time means brightness goes down to 50% initial brightness;  
 The life time of LED will be reduced if LED is driven by high current, high ambient temperature and humidity conditions;  
 Typical operating life time is an estimated data.

## ■ ELECTRO-OPTICAL CHARACTERISTICS

Ta=25°C±2°C. DVDD =3.3V, If=140mA.

Parameter	Symbol	Condition	Min.	Typ.	Max.	Unit	Remark	Notes	
Response Time	Tr + Tf	θ=0°	-	25	50	ms	FIG 1, 2	4	
Contrast Ratio	Cr		400	500	-	---	FIG 1, 3	1	
Luminance Uniformity	δ White		70	75	-	%	FIG 1, 3	3	
Surface Luminance	Lv		330	420	-	cd/m <sup>2</sup>	FIG 1, 3	2	
Viewing Range	Angle	θ	∅ = 90°	40	50	-	deg	FIG 3.	6
			∅ = 270°	60	70	-	deg		
			∅ = 0°	60	70	-	deg		
			∅ = 180°	60	70	-	deg		
CIE (x,y) Chromaticity	Red	x	0.510	0.560	0.610	---	FIG 1, 3	5	
		y	0.296	0.346	0.396				
	Green	x	0.303	0.353	0.403				
		y	0.525	0.575	0.625				
	Blue	x	0.096	0.146	0.196				
		y	0.035	0.085	0.135				
	White	x	0.249	0.299	0.349				
		y	0.266	0.316	0.366				
NTSC	-	-	-	47	-	%	-	-	

Note 1. Contrast Ratio (CR) is defined by following formula. For more information see FIG 3.

$$\text{Contrast Ratio} = \frac{\text{Average Surface Luminance with all white pixels (P1, P2, P3, P4, P5)}}{\text{Average Surface Luminance with all black pixels (P1, P2, P3, P4, P5)}}$$

Note 2. Surface luminance is the LCD surface luminance with all pixels displaying white state. For more information see FIG 3.

$$L_v = \text{Average Surface Luminance with all white pixels (P1, P2, P3, P4, P5)}$$

Note 3. The uniformity in surface luminance (δ White) is determined by measuring luminance at each test position 1 through 5, and then dividing the maximum luminance of 5 points luminance by minimum luminance of 5 points luminance. For more information see FIG 3.

$$\delta \text{ White} = \frac{\text{Minimum Surface Luminance with all white pixels (P1, P2, P3, P4, P5)}}{\text{Maximum Surface Luminance with all white pixels (P1, P2, P3, P4, P5)}}$$

Note 4. Response time is the time required for the display to transition from white to black (Rise Time, Tr) and from black to white (Fall Time, Tf). For additional information see FIG 2.

Note 5. CIE (x,y) chromaticity, color coordinates measured at center point of LCD.

Note 6. Viewing angle is the angle at which the contrast ratio is greater than a specific value. For TFT module, the specific value of contrast ratio is 10. For monochrome module, the specific value of contrast ratio is 2. The angles are determined for the horizontal or x axis and the vertical or y axis with respect to the z axis which is normal to the LCD surface. For more information see FIG 4.

Note 7. For viewing angle and response time testing, the testing data is based on Autronic-Melchers's ConoScope. Series Instruments. For contrast ratio, Surface luminance, Luminance uniformity, and CIE, the test data is based on TOPCON's BM-5 photo detector.

FIG 1. The setup of optical measurement.

The optical characteristics should be measured in a stable, windless, and dark room.

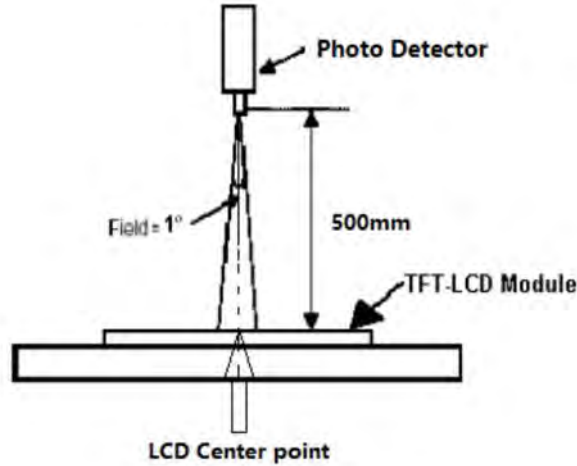

FIG 2. The Definition of Response Time

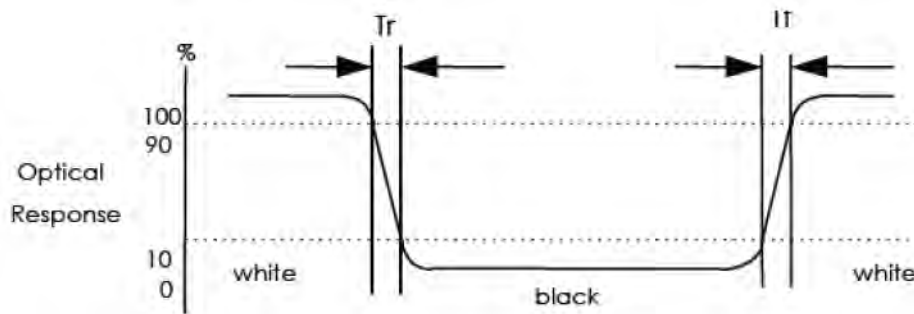
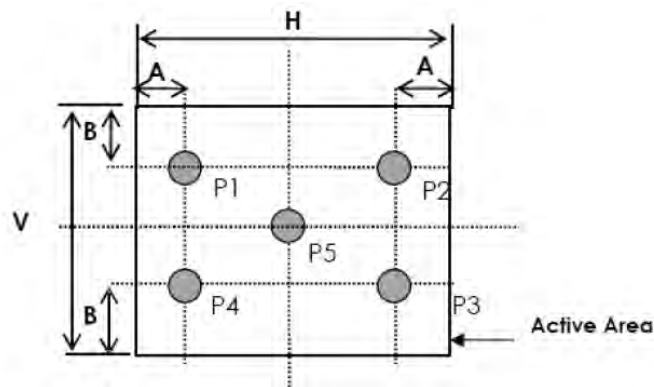

FIG 3. Measuring method for contrast ratio, surface luminance, Luminance uniformity, CIE (x,y) chromaticity.



A:  $H/6$

B:  $V/6$

H, V: Active Area

Light spot size  $\varnothing = 7\text{mm}$ , 500mm distance from the LCD surface to detector lens.

Measurement instrument is TOPCON's luminance meter BM-5.

FIG 4. The definition of viewing angle

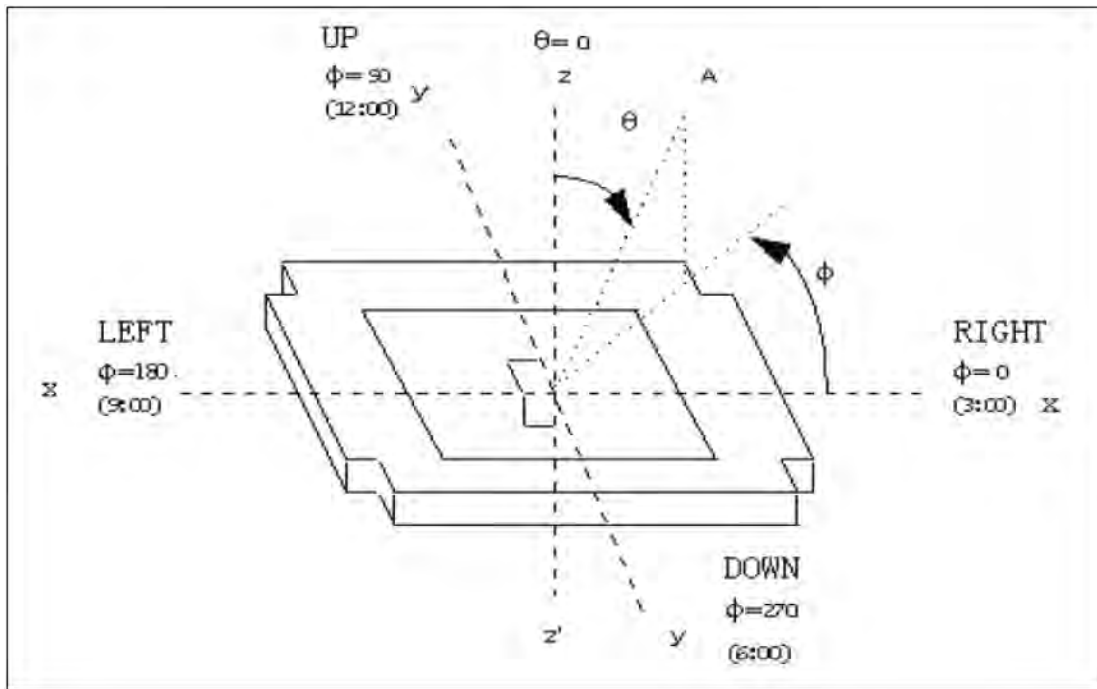

## ■ INTERFACE DESCRIPTION

### 1. Signal Input Port

Pin No.	Symbol	Description	Note
1	CN3: USB Input	No connection. (This is to connect the Touch Panel of this module to a USB input to act as a USB-HID device.)	
2	CN4: HDMI Input (HDMI 1.2)	This is a full-size HDMI connector meant to connect the HDMI source signal (Video) to this module. The on-board HDMI Receiver does not scale video resolutions. Therefore, the output resolution of the source must be 800x480. In most application, this is automatically detected by the HDMI source.	Note 1

Note 1: The display module shows when no HDMI signal is detected, refer to below:

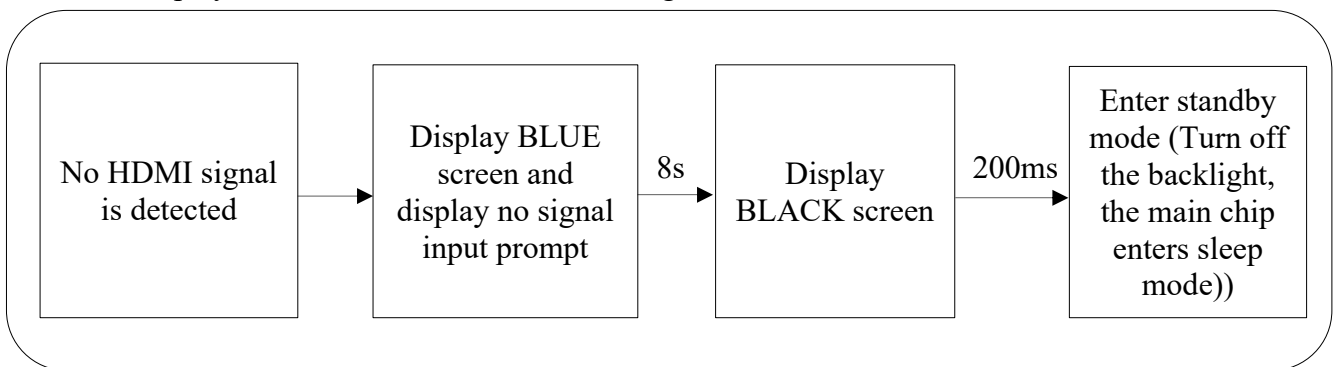

### 2. Power Supply and Backlight Brightness Control Port

Pin No.	Symbol	Description
1	VCC(+12V)	Power supply voltage.
2	GND	Ground.
3	GND	Ground.
4	BL_PWM	PWM dimming. When not use, leave it float.
5	BL_EN	Backlight On/Off control, BL_EN="1" or "NC", backlight ON; BL_EN="0", backlight OFF. When not use, leave it float.



## ■ APPLICATION NOTES

-----

## ■ RELIABILITY TEST

No.	Test Item	Test Condition	Remark
1	High Temperature Storage Test	80°C ± 2°C / 240Hrs.	IEC60068-2-2 GB2423.2
2	Low Temperature Storage Test	-30°C ± 2°C / 240Hrs.	IEC60068-2-1 GB2423.1
3	High Temperature Operating Test	70°C ± 2°C / 240Hrs.	IEC60068-2-2 GB2423.2
4	Low Temperature Operating Test	-20°C ± 2°C / 240Hrs.	IEC60068-2-1 GB2423.1
5	High Temperature and High Humidity Operation Test	60 ± 5°C, 90%RH 240Hrs.	IEC60068-2-3 GB/T2423.3
6	Thermal Shock Test (Non-operating)	-30±2°C(30Min.) ~25±2°C(5Min.) ~80±2°C(30Min.) 100Cycles	IEC60068-2-14 GB2423.22
7	Vibration Test (Non-operating)	Frequency: 10~55Hz Amplitude: 1.5mm Sweep Time: 11Mins Test Period: 6 Cycles for Each Direction of X, Y, Z (Packing Condition)	IEC60068-2-6 GB2423.10
8	Shock Test (Non-operating)	100G, 6Ms Direction: ±X, ±Y, ±Z Cycle: 3 Times	IEC60068-2-27 GB/T2423.5
9	Electro Static Discharge Test	R: 330Ω, C:150pF, 5points/panel Air: ±8KV, 5times; Contact: ±4KV, 5times; (Environment: 15°C~35°C, 30%~60%, 86Kpa~106Kpa)	IEC61000-4-2 GB/T17626.2

Note 1: Without water condensation.

Note 2: The function test shall be conducted after 2 hours storage at the room temperature (25°C±2°C) and room humidity (65%±5%) after removed from the test chamber. In the standard conditions, there shall be no functional defects occurred.

**INSPECTION CRITERION**

	<p>OUTGOING QUALITY STANDARD</p>	<p>PAGE 1 OF 4</p>
<p>TITLE: FUNCTIONAL TEST &amp; INSPECTION CRITERIA</p>		

This specification is made to be used as the standard acceptance/rejection criteria for TFT module.

**1. Sample Plan**

- 1.1 Lot size: Quantity per shipment lot per model
- 1.2 Sampling type: Normal inspection, Single sampling
- 1.3 Inspection level: II
- 1.4 Sampling table: MIL-STD-105D
- 1.5 Acceptable quality level (AQL)
  - Major defect: AQL=0.65
  - Minor defect: AQL=1.50

**2. Inspection Condition**

- 2.1 Ambient conditions
  - a. Temperature: Room temperature  $25\pm 5^{\circ}\text{C}$
  - b. Humidity:  $(60\pm 10)\% \text{RH}$
  - c. Illumination: Single fluorescent lamp non-directive (300 to 700 Lux)
- 2.2 Viewing distance
 

The distance between the LCD and the inspector's eyes shall be at least  $35\pm 5\text{cm}$ .
- 2.3 Viewing angle
 

U/D:  $45^{\circ} / 45^{\circ}$ , L/R:  $45^{\circ} / 45^{\circ}$

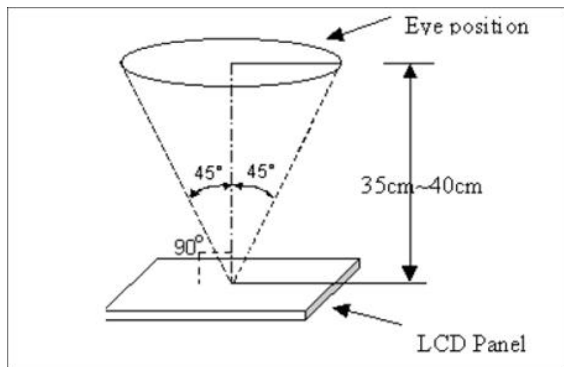

**3. Definition of Inspection Item**

3.1 Definition of inspection zone in LCD module (LCM)

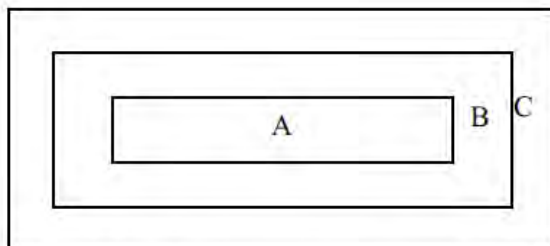

**Fig.1 Inspection zones in an LCD**

- Zone A: Character / Digit area (Active area)
- Zone B: Viewing area except Zone A (Zone A + Zone B=minimum viewing area)
- Zone C: Outside viewing area (invisible area after assembly in customer's product)

<b>OUTGOING QUALITY STANDARD</b>	PAGE 2 OF 4
----------------------------------	-------------

**TITLE: FUNCTIONAL TEST & INSPECTION CRITERIA**

Note: As a general rule, visual defects in Zone C are permissible, when it is no trouble for quality and assembly of customer's product. If any visual defect in Zone C is impermissible, customers need to inform us by written.

**4. Inspection Plan**

Defects are classified as major defects and minor defects according to the degree of defectiveness defined herein.

**4.1 Major defect**

Item No.	Items To Be Inspected	Inspection Standard
4.1.1	All Functional Defects	1) No display 2) Display abnormally 3) Short circuit 4) Line defect 5) Excess power consumption
4.1.2	Missing	Missing function component
4.1.3	Crack	Glass crack

**4.2 Major defect**

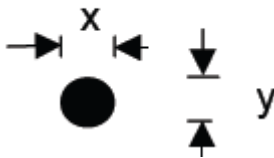
Item No.	Items To Be Inspected	Inspection Standard	
4.2.1	Spot Defect Including Black spot White spot Pinhole Foreign particle Polarizer dirt	For dark / white spot is defined $\varphi = (x+y) / 2$ 	
		Size $\varphi$ (mm)	Acceptable Quantity
		$\varphi \leq 0.25$ 2mm(min) apart	Ignore
		$0.25 < \varphi \leq 0.50$ 5mm(min) apart	5
		$0.50 < \varphi$	Not allowed

OUTGOING QUALITY STANDARD		PAGE 3 OF 4	
TITLE: FUNCTIONAL TEST & INSPECTION CRITERIA			
4.2.2	Line Defect Including Black line White line Scratch	Defined 	
		Width (mm) Length (mm)	Acceptable Quantity
		$W \leq 0.05$ and $L \leq 10$	Ignore
		$0.05 < W \leq 0.08$ and $L \leq 10$ 5mm(min) apart	5
		$0.08 < W \leq 0.10$ and $L \leq 5$ 5mm(min) apart	3
		$0.10 < W$ or $10 < L$	Not allowed
4.2.3	Polarizer Dent / Bubble	Size $\varphi$ (mm)	Acceptable Quantity
		$\varphi \leq 0.30$	Ignore
		Non visible area	Ignore
		$0.30 < \varphi \leq 0.50$ 5mm(min) apart	5
		$0.50 < \varphi$	Not allowed
4.2.4	Electrical Dot Defect	Bright and black dot define: and 	
		Inspection pattern: Full white, Full black, Red, Green and Blue screens	
		Item	Acceptable Quantity
		Black dot defect	5
		Bright dot defect	2
Total Dot	5		

	OUTGOING QUALITY STANDARD	PAGE 4 OF 4
TITLE: FUNCTIONAL TEST & INSPECTION CRITERIA		

4.2.5	Touch Panel Chips	1. Corner chips:	
		Size (mm)	Acceptable Quantity
		$X \leq 3\text{mm}$ $Y \leq 3\text{mm}$ $Z \leq T$	Ignore T: Glass thickness X: Length Y: Width Z: Thickness
		2. Side chips:	
		Size (mm)	Acceptable Quantity
		$X \leq 5\text{mm}$ $Y \leq 3\text{mm}$ $Z \leq T$	Ignore T: Glass thickness X: Length Y: Width Z: Thickness
4.2.6	Touch Panel Newton Ring	Compare with limit sample	

Note: 1. Dot defect is defined as the defective area of the dot area is larger than 50% of the dot area.  
 2. The distance between black dot defects or black and bright dot defects should be more than 5mm apart. The distance between two bright dot defects should be more than 15mm apart.  
 3. Polarizer bubble is defined as the bubble appears on active display area. The defect of polarizer bubble shall be ignored if the polarizer bubble appears on the outside of active display area.  
 4. Mura is checker by 6% ND filter.  
 5. Foreign particle on the surface of the LCM should be ignore.

## ■ PRECAUTIONS FOR USING LCD MODULES

### ◆ Handling Precautions

1. The display panel is made of glass and polarizer. As glass is fragile. It tends to become or chipped during handling especially on the edges. Please avoid dropping or jarring. Do not subject it to a mechanical shock by dropping it or impact.
2. If the display panel is damaged and the liquid crystal substance leaks out, be sure not to get any in your mouth. If the substance contacts your skin or clothes, wash it off using soap and water.
3. Do not apply excessive force to the display surface or the adjoining areas since this may cause the color tone to vary. Do not touch the display with bare hands. This will stain the display area and degraded insulation between terminals (some cosmetics are determined to the polarizer).
4. The polarizer covering the display surface of the LCD module is soft and easily scratched. Handle this polarizer carefully. Do not touch, push or rub the exposed polarizers with anything harder than an HB pencil lead (glass, tweezers, etc.). Do not put or attach anything on the display area to avoid leaving marks on. Condensation on the surface and contact with terminals due to cold will damage, stain or dirty the polarizer. After products are tested at low temperature they must be warmed up in a container before coming is contacting with room temperature air.
5. If the display surface becomes contaminated, breathe on the surface and gently wipe it with a soft dry cloth. If it is heavily contaminated, moisten cloth with one of the following solvents.
  - Isopropyl alcohol
  - Ethyl alcohol

Do not scrub hard to avoid damaging the display surface.

6. Solvents other than those above-mentioned may damage the polarizer. Especially, do not use the following.
  - Water
  - Ketone
  - Aromatic solvents
7. Wipe off saliva or water drops immediately, contact with water over a long period of time may cause deformation or color fading. Avoid contacting oil and fats.
8. Exercise care to minimize corrosion of the electrode. Corrosion of the electrodes is accelerated by water droplets, moisture condensation or a current flow in a high-humidity environment.
9. Install the LCD Module by using the mounting holes. When mounting the LCD module make sure it is free of twisting, warping and distortion. In particular, do not forcibly pull or bend the I/O cable or the backlight cable.
10. Do not attempt to disassemble or process the LCD module.
11. If the logic circuit power is off, do not apply the input signals.
12. Electro-Static Discharge Control. Since this module uses a CMOS LSI, the same careful attention should be paid to electrostatic discharge as for an ordinary CMOS IC. To prevent destruction of the elements by static electricity, be careful to maintain an optimum work environment.
13. Electro-Static Discharge Control. Since this module uses a CMOS LSI, the same careful attention should be paid to electrostatic discharge as for an ordinary CMOS IC. To prevent destruction of the elements by static electricity, be careful to maintain an optimum work environment.
  - Before remove LCM from its packing case or incorporating it into a set, be sure the module and your body have the same electric potential. Be sure to ground the body when handling the LCD modules.
  - Tools required for assembling, such as soldering irons, must be properly grounded. make certain the AC power source for the soldering iron does not leak. When using an electric screwdriver to attach LCM, the screwdriver should be of ground potentiality to minimize as much as possible any transmission of electromagnetic waves produced sparks coming from the commutator of the motor.



- To reduce the amount of static electricity generated, do not conduct assembling and other work under dry conditions. To reduce the generation of static electricity be careful that the air in the work is not too dried. A relative humidity of 50%-60% is recommended. As far as possible make the electric potential of your work clothes and that of the work bench the ground potential

- The LCD module is coated with a film to protect the display surface. Exercise care when peeling off this protective film since static electricity may be generated.

- Since LCM has been assembled and adjusted with a high degree of precision, avoid applying excessive shocks to the module or making any alterations or modifications to it.

- Do not alter, modify or change the shape of the tab on the metal frame.

- Do not make extra holes on the printed circuit board, modify its shape or change the positions of components to be attached.

- Do not damage or modify the pattern writing on the printed circuit board.

- Absolutely do not modify the zebra rubber strip (conductive rubber) or heat seal connector.

- Except for soldering the interface, do not make any alterations or modifications with a soldering iron.

- Do not drop, bend or twist LCM.

**◆ Handling Precaution for LCM**

LCM is easy to be damaged.  
Please note below and be careful for handling!

**Correct handling:**

As above picture, please handle with anti-static gloves around LCM edges.

**Incorrect handling:**

Please don't touch IC directly.



Please don't stack LCM.

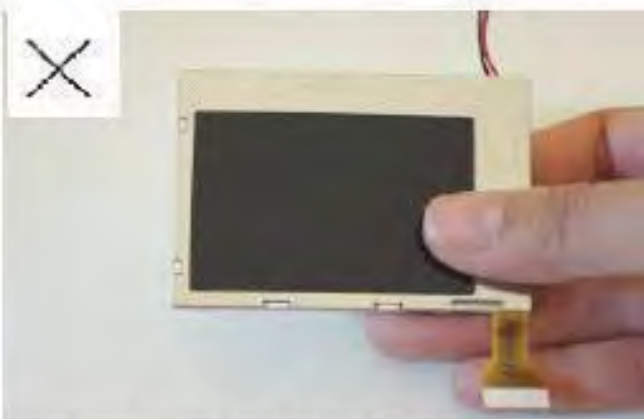

Please don't hold the surface of panel.



Please don't stretch interface of output, such as FPC cable.

**◆ Handling Precaution for LCD**

LCD is easy to be damaged.  
Please note below and be careful for handling!

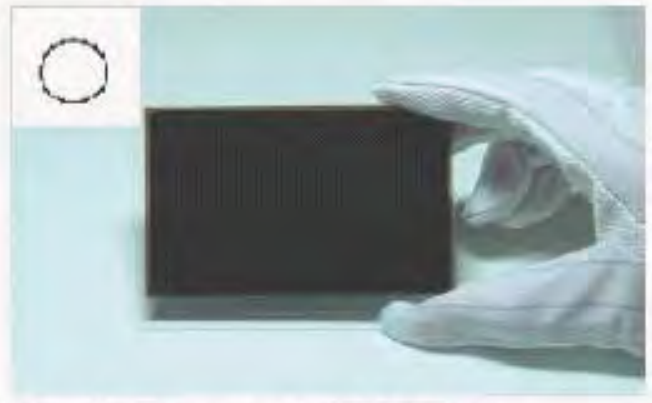
**Correct handling:**

As above photo, please handle with anti-static gloves around LCD edges.

**Incorrect handling:**

Please don't stack the LCDS.

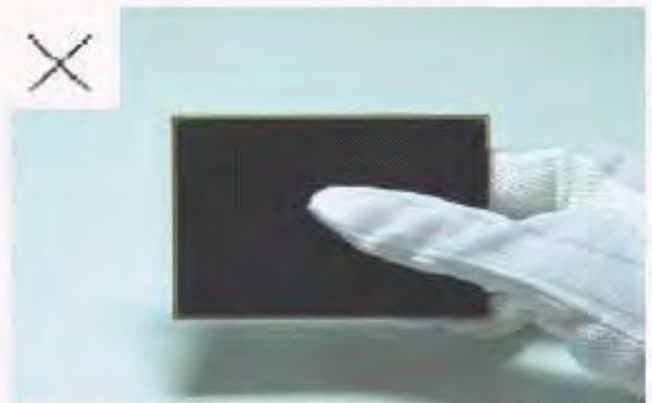

Please don't hold the surface of LCD.

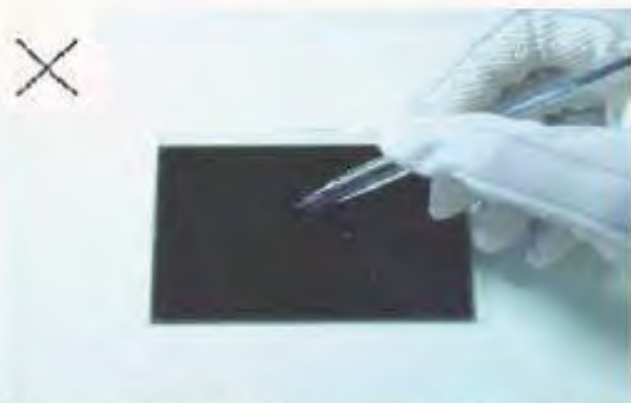

Please don't operate with sharp stick such as pens.

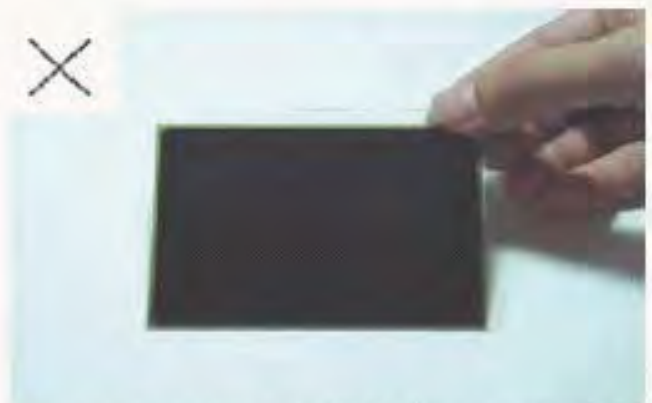

Please don't touch ITO glass without anti-static gloves.

### ◆ Storage Precautions

When storing the LCD modules, the following precaution is necessary.

1. Store them in a sealed polyethylene bag. If properly sealed, there is no need for the desiccant.
2. Store them in a dark place. Do not expose to sunlight or fluorescent light, keep the temperature between 0°C and 35°C, and keep the relative humidity between 40%RH and 60%RH.
3. The polarizer surface should not come in contact with any other objects. (We advise you to store them in the anti-static electricity container in which they were shipped.)

### ◆ Others

1. Liquid crystals solidify under low temperature (below the storage temperature range) leading to defective orientation or the generation of air bubbles (black or white). Air bubbles may also be generated if the module is subject to a low temperature.
2. If the LCD modules have been operating for a long time showing the same display patterns, the display patterns may remain on the screen as ghost images and a slight contrast irregularity may also appear. A normal operating status can be regained by suspending use for some time. It should be noted that this phenomenon does not adversely affect performance reliability.
3. To minimize the performance degradation of the LCD modules resulting from destruction caused by static electricity etc., exercise care to avoid holding the following sections when handling the modules.
  - Exposed area of the printed circuit board.
  - Terminal electrode sections.

### ◆ Using LCD Modules

#### 1. Installing LCD Modules

1.1 The hole in the printed circuit board is used to fix LCM as shown in the picture below. Attend to the following items when installing the LCM.

1.1.1 Cover the surface with a transparent protective plate to protect the polarizer and LC cell.

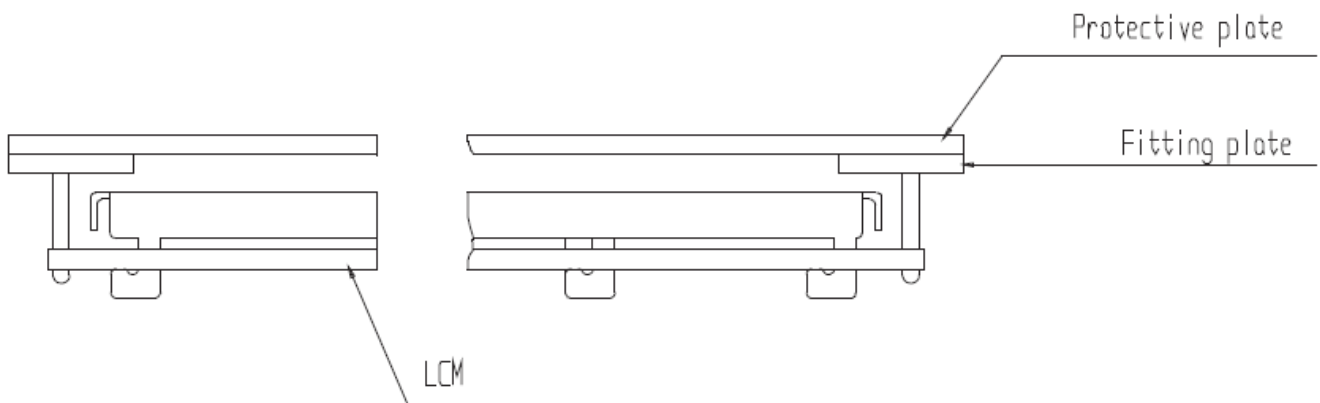

1.1.2 When assembling the LCM into other equipment, the spacer to the bit between the LCM and the fitting plate should have enough height to avoid causing stress to the module surface, refer to the individual specifications for measurements. The measurement tolerance should be  $\pm 0.1$ mm.

## 2. Precaution For Assemble The Module With BTB Connector

Please note the position of the male and female connector position, don't assemble or assemble like the method which the following picture shows.

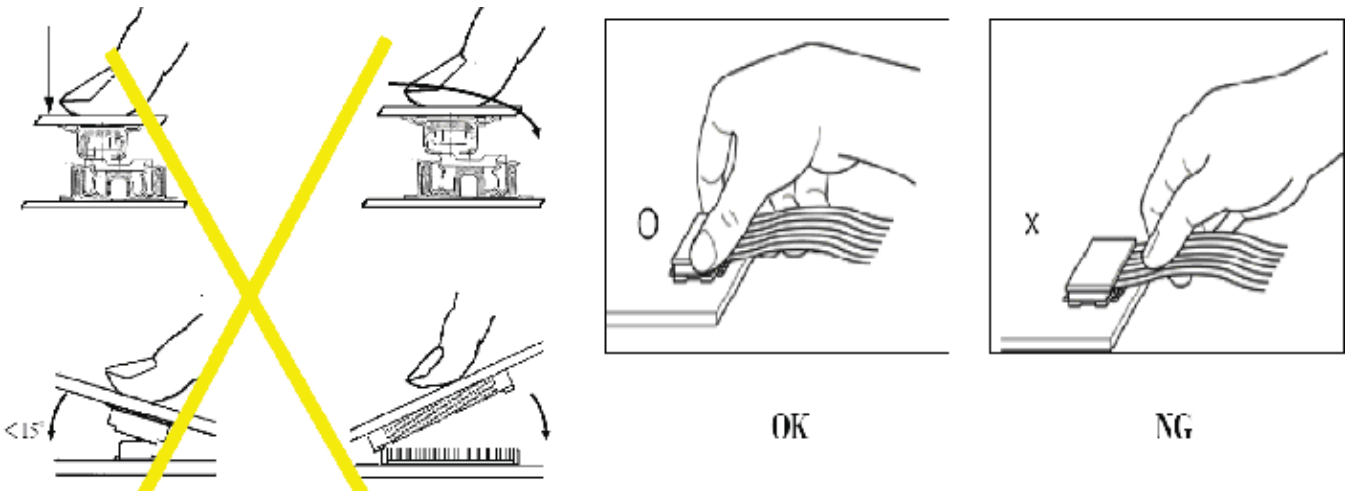

### ◆ Precaution For Soldering To The LCM

	Hand Soldering	Machine Drag Soldering	Machine Press Soldering
No ROHS Product	290°C ~ 350°C. Time: 3~5S.	330°C ± 350°C. Speed: 4~8mm/s.	300°C ± 330°C. Time: 3~6S. Press: 0.8~1.2Mpa
ROHS Product	340°C ~ 370°C. Time: 3~5S.	350°C ± 370°C. Speed: 4~8mm/s.	330°C ± 360°C. Time: 3~6S. Press: 0.8~1.2Mpa

1. If soldering flux is used, be sure to remove any remaining flux after finishing to soldering operation. (This does not apply in the case of a non-halogen type of flux.) It is recommended that you protect the LCD surface with a cover during soldering to prevent any damage due to flux spatters.
2. When soldering the electroluminescent panel and PC board, the panel and board should not be detached more than three times. This maximum number is determined by the temperature and time conditions mentioned above, though there may be some variance depending on the temperature of the soldering iron.
3. When remove the electroluminescent panel from the PC board, be sure the solder has completely melted, the soldered pad on the PC board could be damaged.

### ◆ Precaution For Operation

1. Viewing angle varies with the change of liquid crystal driving voltage (VLCD). Adjust VLCD to show the best contrast.
2. It is an indispensable condition to drive LCD's within the specified voltage limit since the higher voltage then the limit cause the shorter LCD life. An electrochemical reaction due to direct current causes LCD's undesirable deterioration, so that the use of direct current drive should be avoided.
3. Response time will be extremely delayed at lower temperature than the operating temperature range and on the mean malfunction or out of order with LCD's. Which will come back in the specified operating temperature.
4. If the display area is pushed hard during operation, the display will become abnormal. However, it will return to normal if it is turned off and then back on.
5. A slight dew depositing on terminals is a cause for electro-chemical reaction resulting in terminal open circuit. Usage under the maximum operating temperature, 50%RH or less is required.
6. Input each signal after the positive/negative voltage becomes stable.

7. Please keep the temperature within specified range for use and storage. Polarization degradation, bubble generation or polarizer peel-off may occur with high temperature and high humidity.

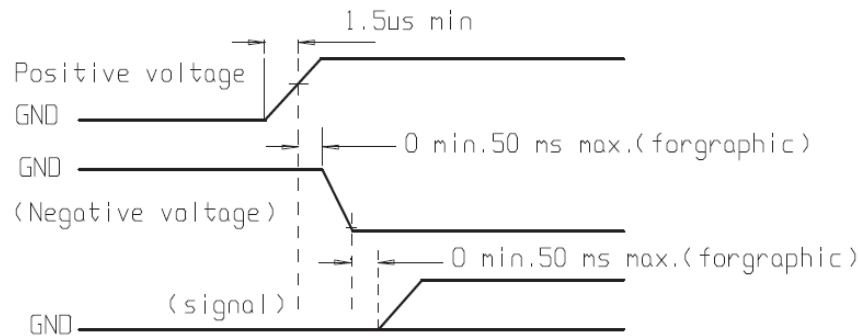

#### ◆ Safety

1. It is recommended to crush damaged or unnecessary LCDs into pieces and wash them off with solvents such as acetone and ethanol, which should later be burned.
2. If any liquid leaks out of a damaged glass cell and comes in contact with the hands, wash off thoroughly with soap and water.

#### ◆ Limited Warranty

Unless agreed between Multi-Inno and customer, Multi-Inno will replace or repair any of its LCD modules which are found to be functionally defective when inspected in accordance with Multi-Inno LCD acceptance standards (copies available upon request) for a period of one year from date of production. Cosmetic/visual defects must be returned to Multi-Inno within 90 days of shipment. Confirmation of such date shall be based on data code on product. The warranty liability is limited to repair and/or replacement on the terms set forth above. Multi-Inno will not be responsible for any subsequent or consequential events.

#### ◆ Return LCM Under Warranty

No warranty can be granted if the precautions stated above have been disregarded. The typical examples of violations are:

- Broken LCD glass.
- PCB eyelet is damaged or modified.
- PCB conductors damaged.
- Circuit modified in any way, including addition of components.
- PCB tampered with by grinding, engraving or painting varnish.
- Soldering to or modifying the bezel in any manner.

Module repairs will be invoiced to the customer upon mutual agreement. Modules must be returned with sufficient description of the failures or defects. Any connectors or cable installed by the customer must be removed completely without damaging the PCB eyelet, conductors and terminals.

#### ■ PRIOR CONSULT MATTER

1. For Multi-Inno standard products, we keep the right to change material, process ... for improving the product property without notice on our customer.
2. For OEM products, if any change needed which may affect the product property, we will consult with our customer in advance.
3. If you have special requirement about reliability condition, please let us know before you start the test on our samples.