





<i>Product Specification</i>	<i>Model:</i>	AWK-800480T50N35	<i>Rev. No.</i>	<i>Issued Date.</i>	<i>Page.</i>
			A	2023/10/04	1/23

Thin Film Transistor LCD MODULE  
MODEL: AWK-800480T50N35  
Customer's No.:

Acceptance

10-1 Floor, No. 192, Tahtung Road,  
Sec. 3, Hsi-Chih Dist,  
New Taipei City, Taiwan

Approved and Checked by

Approved by	Checked by		Made by
			





<i>Product Specification</i>	<i>Model:</i>	AWK-800480T50N35	<i>Rev. No.</i>	<i>Issued Date.</i>	<i>Page.</i>
			A	2023/10/04	3/23

## Table of Contents

<b>List</b>	<b>Description</b>	<b>Page No.</b>
	Cover	1
	Revision Record	2
	Table of Contents	3
1	Scope	4
2	General Information	4
3	External Dimensions	5
4	Interface Description	6
5	Absolute Maximum Ratings	7
6	DC Characteristics	7
7	Timing Characteristics	8
8	Backlight Characteristics	12
9	Optical Characteristics	13
10	Reliability Test Conditions and Methods	15
11	Inspection Standard	16
12	Handling Precautions	20
13	Precaution for Use	22
14	Packing	23



<i>Product Specification</i>	<i>Model:</i>	AWK-800480T50N35	<i>Rev. No.</i>	<i>Issued Date.</i>	<i>Page.</i>
			A	2023/10/04	4/23

## 1. Scope

This specification defines general provisions as well as inspection standards for TFT module supplied by ACROWISE electronics. If the event of unforeseen problem or unspecified items may occur, naturally shall negotiate and agree to solution

## 2. General Information

ITEM	STANDARD VALUES	UNITS
LCD type	5.0" TFT	--
Dot arrangement	800 (RGB)×480	dots
Color filter array	RGB vertical stripe	--
Display mode	Normally Black IPS	-
Eyes Viewing Direction	80/80/80/80	
Driver IC	ST7265	--
Module size	120.7(W)×75.8(H)×2.8(T)	mm
Active area	108.0(W)×64.80(H)	mm
Dot pitch	0.135(W)×0.135(H)	mm
Interface	24-bit Parallel RGB Interface	--
Operating temperature	-30 ~ +85	°C
Storage temperature	-30 ~ +85	°C
Back Light	16 White LEDs	--





Product Specification	Model:	AWK-800480T50N35	Rev. No.	Issued Date.	Page.
			A	2023/10/04	6/23

#### 4. Interface Description

PIN NO.	PIN NAME	DESCRIPTION
1	VLED-	LED backlight (Cathode).
2	VLED+	LED backlight (Anode).
3	GND	Ground.
4	VDD	Power supply
5~12	R0~R7	Red Data
13~20	G0~G7	Green Data
21~28	B0~B7	Blue Data
29	GND	Ground.
30	PCLK	Clock
31	DISP	Display on/off
32	HSYNC	Horizontal sync input in RGB mode.
33	VSYNC	Vertical sync input in RGB mode.
34	DE	Data enable input. Active high to enable the input data bus.
35	NC	NC
36	GND	Ground.
37	NC	NC
38	NC	NC
39	NC	NC
40	NC	NC



Product Specification	Model:	AWK-800480T50N35	Rev. No.	Issued Date.	Page.
			A	2023/10/04	7/23

## 5. Absolute Maximum Ratings

Item	Symbol	Min.	Max.	Unit
Power supply	VDD	-0.3	4.0	V
Input Voltage	V <sub>in</sub>	-0.3	VDD +0.3	V
Operating Temperature	TOP	-30	85	°C
Storage Temperature	TST	-30	85	°C
Storage Humidity	HD	20	90	%RH

## 6. DC Characteristics

Item	Symbol	Min.	Typ.	Max.	Unit	Remark
Power supply	VDD	3.1	3.3	3.6	V	-
Power supply current	IVDD	TBD	TBD	TBD	mA	-
Input High Voltage	V <sub>IH</sub>	0.7VDD	-	VDD	V	-
Input Low Voltage	V <sub>IL</sub>	GND	-	0.3 VDD	V	-
Output High Voltage	V <sub>OH</sub>	VDD-0.4	-	VDD	V	-
Output Low Voltage	V <sub>OL</sub>	GND	-	GND+0.4	V	-
I/O Leak Current	ILI	-1	-	1	uA	-



Product Specification	Model:	AWK-800480T50N35	Rev. No.	Issued Date.	Page.
			A	2023/10/04	8/23

## 7. Timing Characteristics

### 7.1. RGB Interface

RGB Mode Selection Table	DCLK	HSYNC	VSYNC	DE
SYNC - DE Mode	Input	Input	Input	Input
SYNC Mode	Input	Input	Input	GND
DE Mode	Input	GND	GND	Input

Note: "Input" means these signals are driven by host side.

#### SYNC Mode

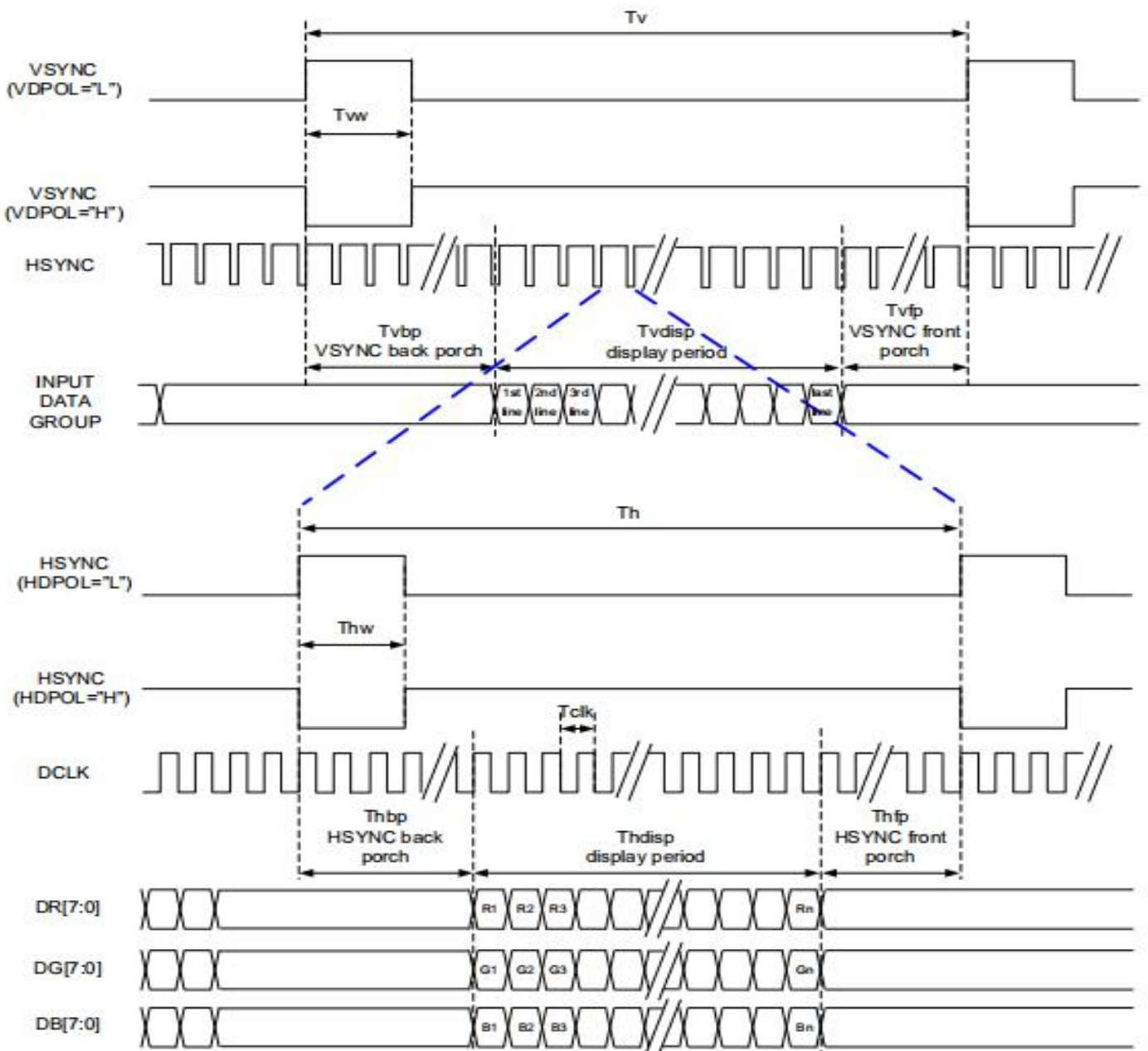



Product Specification	Model:	AWK-800480T50N35	Rev. No.	Issued Date.	Page.
			A	2023/10/04	9/23

**SYNC-DE Mode**

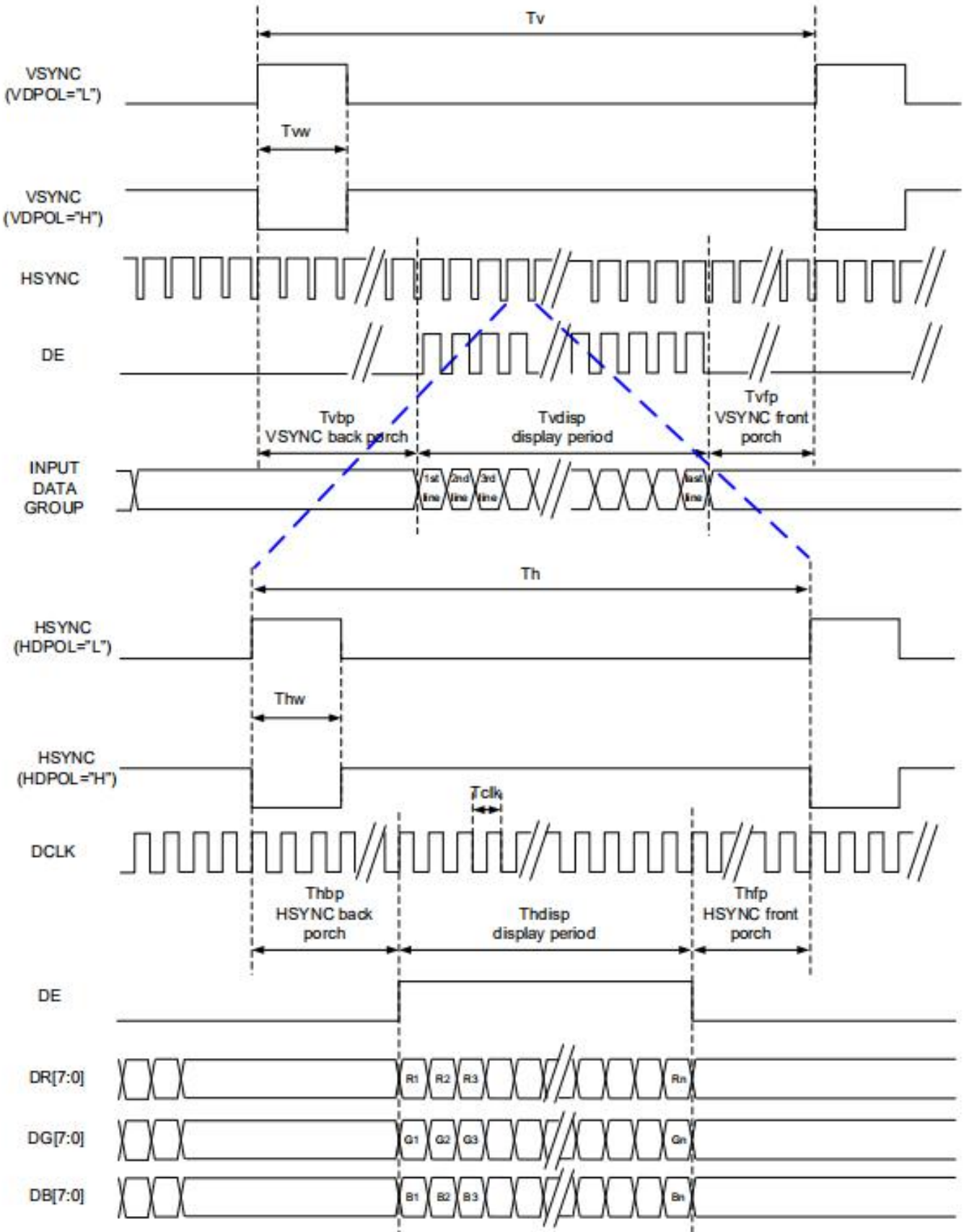



Product Specification	Model:	AWK-800480T50N35	Rev. No.	Issued Date.	Page.
			A	2023/10/04	10/23

**DE Mode**

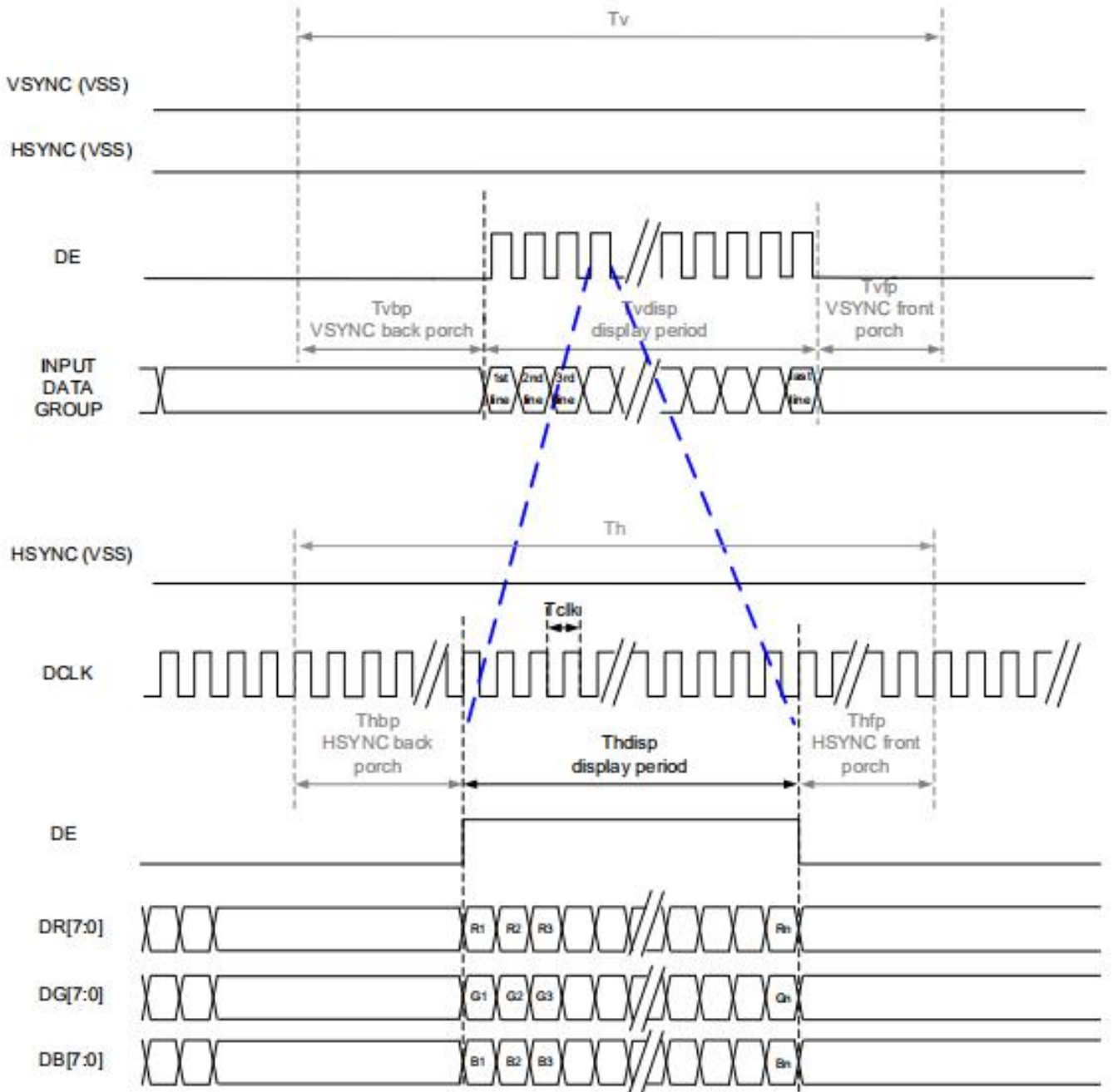



Product Specification	Model:	AWK-800480T50N35	Rev. No.	Issued Date.	Page.
			A	2023/10/04	11/23

## 7.2. Parallel 24-bit RGB Input Timing Table

Parallel 24-bit RGB Input Timing (PVDD=VDD=VDDI= 3.3V, AGND= 0V, TA=25°C).

Parallel 24-bit RGB Interface Timing Table							
Item	Symbol	Min.	Typ.	Max.	Unit	Remark	
DCLK Frequency	Fclk	23	25	27	MHz	.	
HSYNC	Period Time	Th	808	816	848	DCLK	
	Display Period	Thdisp	800			DCLK	
	Back Porch	Thbp	4	8	24	DCLK	
	Front Porch	Thfp	4	8	24	DCLK	
	Pulse Width	Thw	2	4	8	DCLK	
VSYNC	Period Time	Tv	496	512	528	HSYNC	
	Display Period	Tvdisp	480			HSYNC	
	Back Porch	Tvbp	8	16	24	HSYNC	
	Front Porch	Tvfp	8	16	24	HSYNC	
	Pulse Width	Tvw	2	4	8	HSYNC	

Note: 1. The minimum blanking time depends on the GIP timing of the panel specification.

2. To ensure the compatibility of different panels, it is recommended to use the typical setting.

3. It is necessary to keep  $Tvbp = 16$  and  $Thbp = 8$  in sync mode. DE mode is unnecessary to keep it.

4. The maximum DCLK Frequency is 27MHz. If the case needs faster DCLK, please contact Sitronix.



Product Specification	Model:	AWK-800480T50N35	Rev. No.	Issued Date.	Page.
			A	2023/10/04	12/23

### 8. Backlight Characteristic

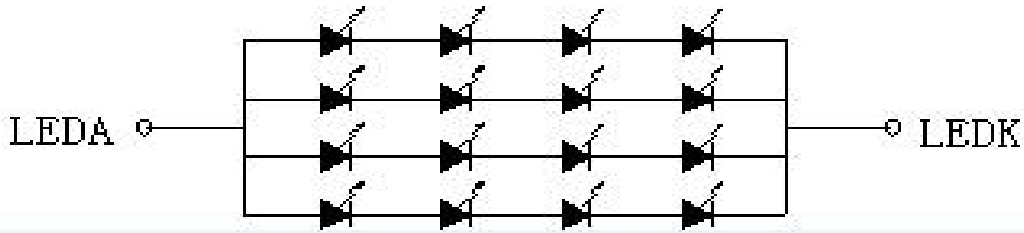

Item	Symbol	MIN	TYP	MAX	UNIT	Test Condition
Supply Voltage	Vf	22	24	26	V	If=80mA
Supply Current	If	-	80	-	mA	
Life Time	-	-	20000	-	Hr	If=80mA
Backlight Color	White					

**Note 1:** The LED Supply Voltage is defined by the number of LED at Ta=25°C and If =80mA.

**Note 2:** LED current is measured by utilizing a high frequency current meter as shown below:

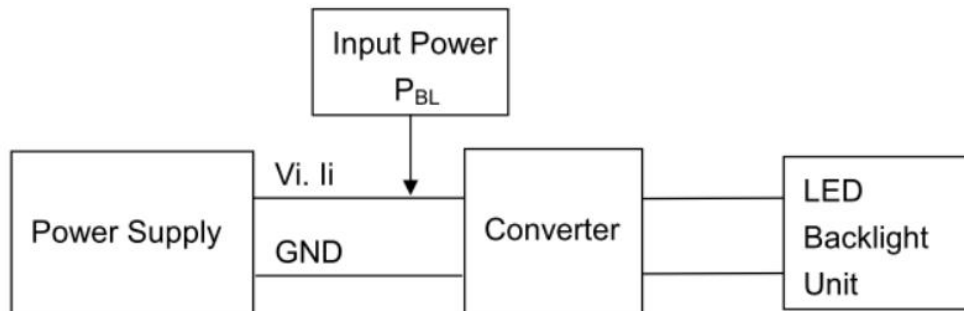

**Note 3:** The “LED life time” is defined as the module brightness decrease to 50% original brightness at Ta=25°C and If = 80mA. The LED lifetime could be decreased if operating If is larger than 80mA.

**Note 4:** LED light bar circuit:

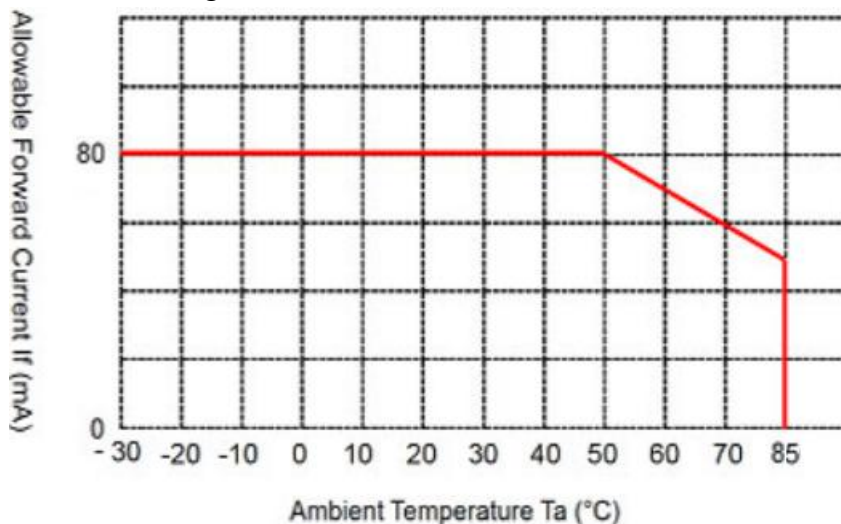



Product Specification	Model:	AWK-800480T50N35	Rev. No.	Issued Date.	Page.
			A	2023/10/04	13/23

### 9. Optical Characteristics

Item	Conditions	Min.	Typ.	Max.	Unit	Note	
Viewing Angle (CR>10)	Horizontal	θL	-	80	-	degree	(1),(2),(6)
		θR	-	80	-		
	Vertical	θT	-	80	-		
		θB	-	80	-		
Luminous Intensity for LCM	-	800	1000	-	cd/m2	If=80mA	
Uniformity for LCM	-	80	-	-	%	If=80mA	
Contrast Ratio	Center	1000	1200	-	-	(1),(3),(6)	
Response Time	Rising + Falling	-	30	40	ms	(1),(4),(6)	
CF Color Chromaticity (CIE1931)	White x	TBD	TBD	TBD	-	(1), (6)	
	White y	TBD	TBD	TBD	-		
	Red x	TBD	TBD	TBD	-		
	Red y	TBD	TBD	TBD	-		
	Green x	TBD	TBD	TBD	-		
	Green y	TBD	TBD	TBD	-		
	Blue x	TBD	TBD	TBD	-		
	Blue y	TBD	TBD	TBD	-		

**Note (1) Measurement Setup:** The LCD module should be stabilized at given temp. 25°C for 15 minutes to avoid abrupt temperature change during measuring. In order to stabilize the luminance, the measurement should be executed after lighting backlight for 15 minutes in a windless room.

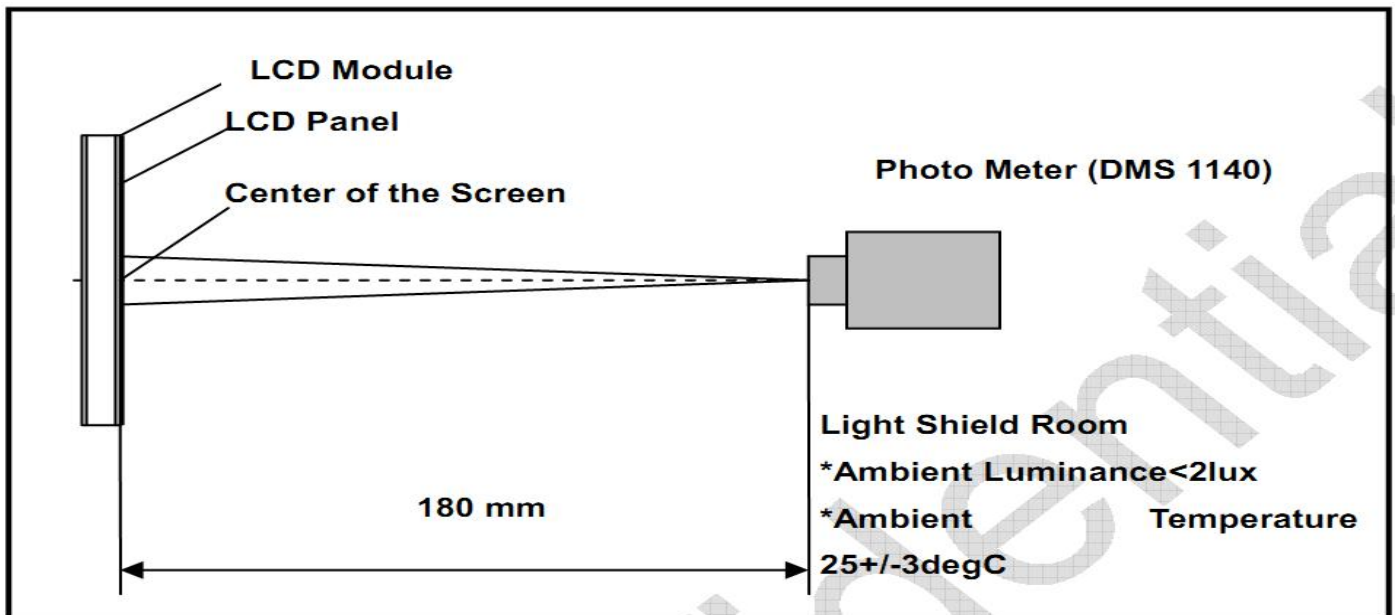



Product Specification	Model:	AWK-800480T50N35	Rev. No.	Issued Date.	Page.
			A	2023/10/04	14/23

**Note (2) Definition of Viewing Angle**

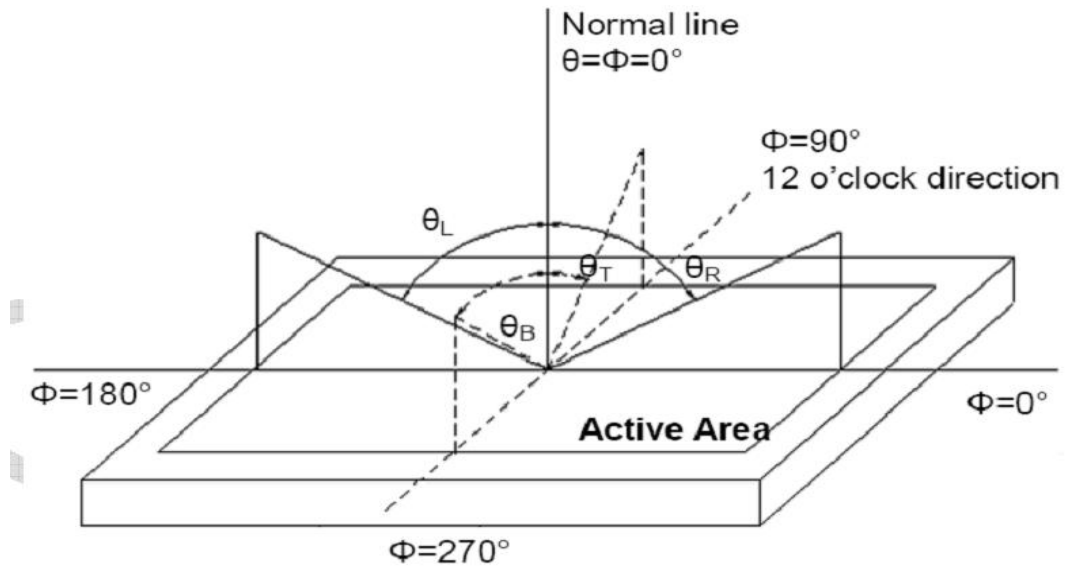

**Note (3) Definition of Contrast Ratio (CR)**

The contrast ratio can be calculated by the following expression

$$\text{Contrast Ratio (CR)} = L_{255} / L_0$$

L255: Luminance of gray level 255, L0: Luminance of gray level 0

**Note (4) Definition of response time**

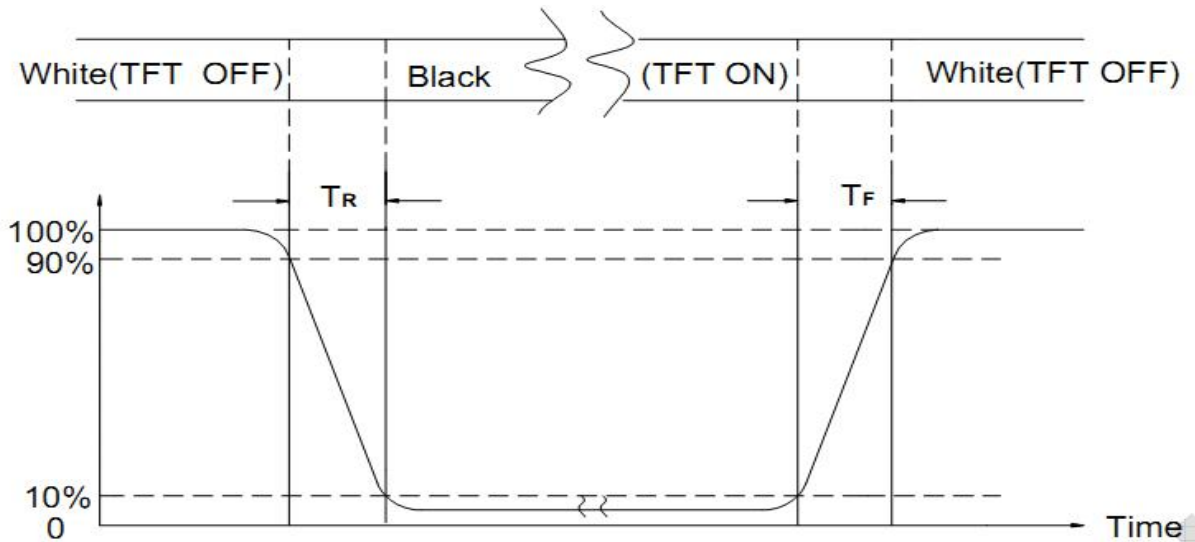

**Note (5) Definition of Transmittance (Module is without signal input)**

$$\text{Transmittance} = \text{Center Luminance of LCD} / \text{Center Luminance of Back Light} \times 100\%$$



**Note (6) Definition of color chromaticity (CIE1931)**

Color coordinates measured at the center point of LCD

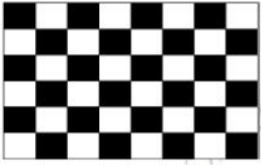

Product Specification	Model:	AWK-800480T50N35	Rev. No.	Issued Date.	Page.
			A	2023/10/04	15/23

### 10. Reliability Test Conditions and Methods

No.	Test Items	Test Condition	Inspection After Test
1	High Temperature Storage	85°C±2°C×96Hours	Inspection after 2~4hours storage at room temperature, the samples should be free from defects: 1, Air bubble in the LCD. 2, Seal leak. 3, Non-display. 4, Missing segments. 5, Glass crack. 6, Current IDD is twice higher than initial value. 7, The surface shall be free from damage. 8, The electric characteristic requirements shall be satisfied.
2	Low Temperature Storage	-30°C±2°C×96Hours	
3	High Temperature Operating	85°C±2°C×96Hours	
4	Low Temperature Operating	-30°C±2°C×96Hours	
5	Temperature Cycle(Storage)	$  \begin{array}{c}  -20^{\circ}\text{C} \xleftrightarrow{(30\text{min})} 25^{\circ}\text{C} \xleftrightarrow{(5\text{min})} 70^{\circ}\text{C} \\  \xleftrightarrow{(30\text{min})} \\  \text{Total 10cycle}  \end{array}  $	
6	Damp Proof Test (Storage)	50°C±5°C×90%RH×96Hours	
7	Vibration Test	Frequency:10Hz~55Hz~10Hz Amplitude:1.5mm X,Y,Z direction for total 3hours (packing condition test will be tested by a carton)	
8	Drooping Test	Drop to the ground from 1M height one time every side of carton. (packing condition test will be tested by a carton)	
9	ESD Test	Voltage:±8KV,R:330Ω,C:150PF,Air Mode,10times	
10	Image Sticking Test	25 ± 2°C Operation with test pattern sustained for 2 hrs, then change to gray pattern immediately. After 5 mins, the mura must be disappeared completely  	

**REMARK:**

- The Test samples should be applied to only one test item.
- Sample side for each test item is 5~10pcs.
- For Damp Proof Test, Pure water(Resistance> 10MΩ)should be used.
- In case of malfunction defect caused by ESD damage, if it would be recovered to normal state after resetting, it would be judge as a good part.
- EL evaluation should be accepted from reliability test with humidity and temperature: Some defects such as black spot/blemish can happen by natural chemical reaction with humidity and Fluorescence EL has.
- Failure Judgment Criterion: Basic Specification Electrical Characteristic, Mechanical Characteristic, Optical Characteristic.



<i>Product Specification</i>	<i>Model:</i>	AWK-800480T50N35	<i>Rev. No.</i>	<i>Issued Date.</i>	<i>Page.</i>
			A	2023/10/04	16/23

## 11. Inspection Standard

### 11.1 Scope

Specifications contain

11.1.1 Display Quality Evaluation

11.1.2 Mechanics Specification

### 11.2 Sampling Plan

Unless there is other agreement, the sampling plan for incoming inspection shall follow MIL-STD-105E.

11.2.1 Lot size: Quantity per shipment as one lot (different model as different lot ).

11.2.2 Sampling type: Normal inspection, single sampling.

11.2.3 Sampling level: Level II.

11.2.4 AQL: Acceptable Quality Level

Major defect: AQL=0.65

Minor defect: AQL=1.5

### 11.3 Panel Inspection Condition

11.3.1 Environment:

Room Temperature: 25±5°C.

Humidity: 65±5% RH.

Illumination: 300 ~ 700 Lux.

11.3.2 Inspection Distance:

35±5 cm

11.3.3 Inspection Angle:

The vision of inspector should be perpendicular to the surface of the Module.

11.3.4 Inspection time:

Perceptibility Test Time: 20 seconds max.



Product Specification	Model:	AWK-800480T50N35	Rev. No.	Issued Date.	Page.
			A	2023/10/04	17/23

### 11.4 Inspection Plan

Class	Item	Judgment	Class
Packing & Indicate	1. Outside and inside package.	"MODEL NO.", "LOT NO." and "QUANTITY" should indicate on the package.	Minor
	2. Model mixed and quantity.	Other model mixed Quantity short or over	Major
	3. Product indication.	"MODEL NO." should indicate on the product.	Major
Assembly	4. Dimension, LCD glass scratch and scribe defect.	According to specification or drawing.	Major
Appearance	5. Viewing area.	Polarizer edge or LCD's sealing line is visible in the viewing area.....Rejected.	Minor
	6. Blemish, black spot, white spot in the LCD and LCD glass cracks.	According to standard of visual inspection.(inside viewing area)	Minor
	7. Blemish, black spot, white spot and scratch on the polarizer.	According to standard of visual inspection.(inside viewing area)	Minor
	8. Bubble in polarizer.	According to standard of visual inspection.(inside viewing area)	Minor
	9. LCD's rainbow color.	Strong deviation color (or newton ring) of LCD.....Rejected. Or according to limited sample.(if needed, and inside viewing area)	Minor
Electrical	10. Electrical and optical characteristics.(contrast Vop chromaticity....etc)	According to specification or drawing.(inside viewing area)	Major
	11. Missing line.	Missing dot line character	Major
	12.Short circuit. Wrong pattern display.	No display, wrong pattern display, current consumption. Out of specification	Major
	13. Dot defect.(for color and TFT)	According to standard of visual Inspection.	Minor



Product Specification	Model:	AWK-800480T50N35	Rev. No.	Issued Date.	Page.
			A	2023/10/04	18/23

### 11.5 Standard Of Visual Inspection

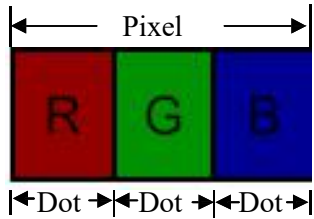
NO.	CLASS	ITEM	JUDGMENT																				
11.5.1	Minor	Black and white spot. Foreign materiel. Dust. Blemish. Scratch.	<p>(A) Round type: <span style="float: right;">Unit: mm</span></p> <table border="1"> <thead> <tr> <th>Diameter (mm.)</th> <th>Acceptable Q'ty</th> </tr> </thead> <tbody> <tr> <td><math>\Phi \leq 0.2</math></td> <td>Disregard</td> </tr> <tr> <td><math>0.2 &lt; \Phi \leq 0.30</math></td> <td>1(Distance&gt;5mm)</td> </tr> <tr> <td><math>0.30 &lt; \Phi</math></td> <td>0</td> </tr> </tbody> </table> <p>Note: <math>\Phi = (\text{length} + \text{width}) / 2</math></p> <p>(B) Linear type: <span style="float: right;">Unit: mm</span></p> <table border="1"> <thead> <tr> <th>Length</th> <th>Width (mm.)</th> <th>Acceptable Q'ty</th> </tr> </thead> <tbody> <tr> <td>--</td> <td><math>W \leq 0.03</math></td> <td>Disregard</td> </tr> <tr> <td><math>L \leq 5.0</math></td> <td><math>0.03 &lt; W \leq 0.07</math></td> <td>2(Distance&gt;5mm)</td> </tr> <tr> <td>--</td> <td><math>0.07 &lt; W</math></td> <td>FOLLOW ROUND TYPE</td> </tr> </tbody> </table>	Diameter (mm.)	Acceptable Q'ty	$\Phi \leq 0.2$	Disregard	$0.2 < \Phi \leq 0.30$	1(Distance>5mm)	$0.30 < \Phi$	0	Length	Width (mm.)	Acceptable Q'ty	--	$W \leq 0.03$	Disregard	$L \leq 5.0$	$0.03 < W \leq 0.07$	2(Distance>5mm)	--	$0.07 < W$	FOLLOW ROUND TYPE
Diameter (mm.)	Acceptable Q'ty																						
$\Phi \leq 0.2$	Disregard																						
$0.2 < \Phi \leq 0.30$	1(Distance>5mm)																						
$0.30 < \Phi$	0																						
Length	Width (mm.)	Acceptable Q'ty																					
--	$W \leq 0.03$	Disregard																					
$L \leq 5.0$	$0.03 < W \leq 0.07$	2(Distance>5mm)																					
--	$0.07 < W$	FOLLOW ROUND TYPE																					
11.5.2	Minor	Dent on polarizer.	<p style="text-align: right;">Unit: mm.</p> <table border="1"> <thead> <tr> <th>Diameter</th> <th>Acceptable Q'ty</th> </tr> </thead> <tbody> <tr> <td><math>\Phi \leq 0.2</math></td> <td>Disregard</td> </tr> <tr> <td><math>0.2 &lt; \Phi \leq 0.7</math></td> <td>2(Distance&gt;5mm)</td> </tr> <tr> <td><math>0.7 &lt; \Phi</math></td> <td>0</td> </tr> </tbody> </table>	Diameter	Acceptable Q'ty	$\Phi \leq 0.2$	Disregard	$0.2 < \Phi \leq 0.7$	2(Distance>5mm)	$0.7 < \Phi$	0												
Diameter	Acceptable Q'ty																						
$\Phi \leq 0.2$	Disregard																						
$0.2 < \Phi \leq 0.7$	2(Distance>5mm)																						
$0.7 < \Phi$	0																						
11.5.3	Minor	Bubble in polarizer.	<p style="text-align: right;">Unit: mm.</p> <table border="1"> <thead> <tr> <th>Diameter</th> <th>Acceptable Q'ty</th> </tr> </thead> <tbody> <tr> <td><math>\Phi \leq 0.2</math></td> <td>Disregard</td> </tr> <tr> <td><math>0.2 &lt; \Phi \leq 0.7</math></td> <td>2(Distance&gt;5mm)</td> </tr> <tr> <td><math>0.7 &lt; \Phi</math></td> <td>0</td> </tr> </tbody> </table>	Diameter	Acceptable Q'ty	$\Phi \leq 0.2$	Disregard	$0.2 < \Phi \leq 0.7$	2(Distance>5mm)	$0.7 < \Phi$	0												
Diameter	Acceptable Q'ty																						
$\Phi \leq 0.2$	Disregard																						
$0.2 < \Phi \leq 0.7$	2(Distance>5mm)																						
$0.7 < \Phi$	0																						
11.5.4	Minor	Dot defect	<table border="1"> <thead> <tr> <th>Items</th> <th>Acceptable Q'ty</th> </tr> </thead> <tbody> <tr> <td>Bright dot</td> <td><math>N \leq 1</math></td> </tr> <tr> <td>Dark dot</td> <td><math>N \leq 2</math></td> </tr> <tr> <td>Total dot</td> <td><math>N \leq 3</math></td> </tr> </tbody> </table> <p>Pixel define : </p> <p>Note1: The definition of dot: The size of a defective dot over 1/2 of whole dot is regarded as one defective dot.          Note 2: Bright dot: Dots appear bright and unchanged in size in which LCD panel is displaying under black pattern.          Note 3: The bright dot defect must be visible through 2% ND filter          Note 4: Dark dot: Dots appear dark and unchanged in size in which LCD panel is displaying under pure red, green, blue pattern.</p>	Items	Acceptable Q'ty	Bright dot	$N \leq 1$	Dark dot	$N \leq 2$	Total dot	$N \leq 3$												
Items	Acceptable Q'ty																						
Bright dot	$N \leq 1$																						
Dark dot	$N \leq 2$																						
Total dot	$N \leq 3$																						
11.5.5	Minor	Mura	ND 5% (In 50% gray screen)																				

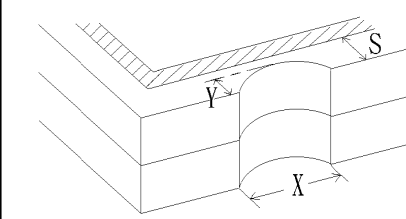
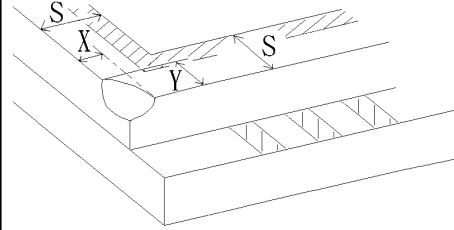
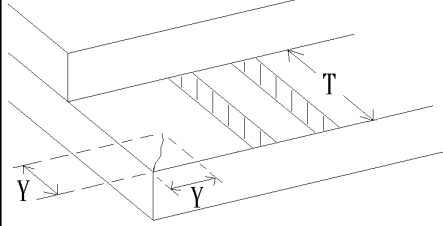
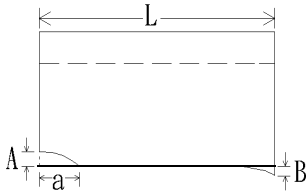
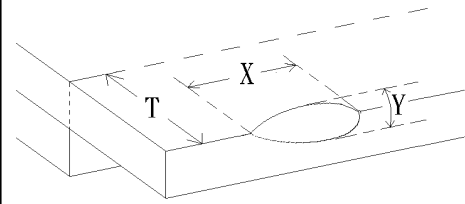
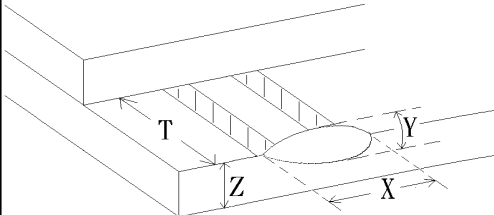
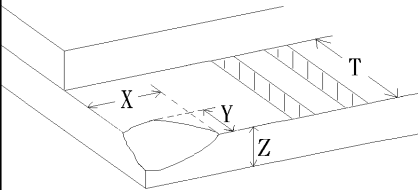

Product Specification	Model:	AWK-800480T50N35	Rev. No.	Issued Date.	Page.
			A	2023/10/04	19/23

No.	Class	Item	Judgment
11.5.6	Minor	LCD glass chipping.	 $Y > S$ Reject
11.5.7	Minor	LCD glass chipping.	 $X \text{ or } Y > S$ Reject
11.5.8	Major	LCD glass crack.	 $Y > (1/2) T$ Reject
11.5.9	Major	LCD glass scribe defect.	 <ol style="list-style-type: none"> <li><math>a &gt; L/3</math>, <math>A &gt; 1.5\text{mm}</math>      Reject</li> <li>B : According to dimension</li> </ol>
11.5.10	Minor	LCD glass chipping. (on the terminal area)	 $\Phi = (x+y)/2 > 2.5\text{mm}$ Reject
11.5.11	Minor	LCD glass chipping. (on the terminal surface)	 $Y > (1/3) T$ Reject
11.5.12	Minor	LCD glass chipping.	 $Y > T$ Reject



<i>Product Specification</i>	<i>Model:</i>	AWK-800480T50N35	<i>Rev. No.</i>	<i>Issued Date.</i>	<i>Page.</i>
			A	2023/10/04	20/23

## 12. Handling Precautions

### 12.1 Mounting Method

The LCD panel of ACROWISE TFT module consists of two thin glass plates with polarizes which easily be damaged. And since the module in so constructed as to be fixed by utilizing fitting holes in the printed circuit board.

Extreme care should be needed when handling the LCD modules.

### 12.2 Caution of LCD Handling And Cleaning

When cleaning the display surface, Use soft cloth with solvent

[Recommended below] and wipe lightly

- Isopropyl alcohol
- Ethyl alcohol

Do not wipe the display surface with dry or hard materials that will damage the polarizer surface.

Do not use the following solvent:

- Water
- Aromatics

Do not wipe ITO pad area with the dry or hard materials that will damage the ITO patterns

Do not use the following solvent on the pad or prevent it from being contaminated:

- Soldering flux
- Chlorine (Cl) , Sulfur (S)

If goods were sent without being silicon coated on the pad, ITO patterns could be damaged due to the corrosion as time goes on.

If ITO corrosion happen by miss-handling or using some materials such as Chlorine (Cl), Sulfur (S) from customer, Responsibility is on customer.

### 12.3 Caution Against Static Charge

The LCD module use C-MOS LSI drivers, so we recommended that you:

Connect any unused input terminal to power or ground, do not input any signals before power is turned on, and ground your body, work/assembly areas, and assembly equipment to protect against static electricity.

### 12.4 Packing

- Module employs LCD elements and must be treated as such.
- Avoid intense shock and falls from a height.
- To prevent modules from degradation, do not operate or store them exposed direct to sunshine or high temperature/humidity



<i>Product Specification</i>	<i>Model:</i>	AWK-800480T50N35	<i>Rev. No.</i>	<i>Issued Date.</i>	<i>Page.</i>
			A	2023/10/04	21/23

## 12.5 Caution for operation

- It is an indispensable condition to drive LCD's within the specified voltage limit since the higher voltage then the limit cause the shorter LCD life.
- An electrochemical reaction due to direct current causes LCD's undesirable deterioration, so that the use of direct current drive should be avoided.
- Response time will be extremely delayed at lower temperature then the operating temperature range and on the other hand at higher temperature LCD's how dark color in them. However those phenomena do not mean malfunction or out of order with LCD's, which will come back in the specified operation temperature.
- If the display area is pushed hard during operation, some font will be abnormally displayed but it resumes normal condition after turning off once.
- Slight dew depositing on terminals is a cause for electro-chemical reaction resulting in terminal open circuit.

Usage under the maximum operating temperature, 50%Rh or less is required.

## 12.6 Storing

In the case of storing for a long period of time for instance, for years for the purpose or replacement use, the following ways are recommended.

- Storage in a polyethylene bag with the opening sealed so as not to enter fresh air outside in it. And with no desiccant.
- Placing in a dark place where neither exposure to direct sunlight nor light's keeping the storage temperature range.
- Storing with no touch on polarizer surface by the anything else.

[It is recommended to store them as they have been contained in the inner container at the time of delivery from us

## 12.7 Safety

- It is recommendable to crash damaged or unnecessary LCD's into pieces and wash off liquid crystal by either of solvents such as acetone and ethanol, which should be burned up later.
- When any liquid leaked out of a damaged glass cell comes in contact with your hands, please wash it off well with soap and water



<i>Product Specification</i>	<i>Model:</i>	AWK-800480T50N35	<i>Rev. No.</i>	<i>Issued Date.</i>	<i>Page.</i>
			A	2023/10/04	22/23

### 13. Precaution for Use

#### 13.1

A limit sample should be provided by the both parties on an occasion when the both parties agreed its necessity. Judgment by a limit sample shall take effect after the limit sample has been established and confirmed by the both parties.

#### 13.2

On the following occasions, the handing of problem should be decided through discussion and agreement between responsible of the both parties.

- When a question is arisen in this specification
- When a new problem is arisen which is not specified in this specifications
- When an inspection specifications change or operating condition change in customer is reported to ACROWISE TFT , and some problem is arisen in this specification due to the change
- When a new problem is arisen at the customer's operating set for sample evaluation in the customer site.



<i>Product Specification</i>	<i>Model:</i>	AWK-800480T50N35	<i>Rev. No.</i>	<i>Issued Date.</i>	<i>Page.</i>
			A	2023/10/04	23/23

14. Packing  
TBD